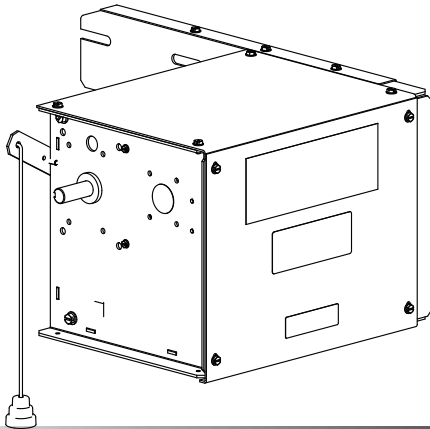


# CDX<sup>®</sup>

The Genuine. The Original.  

**OVERHEAD DOOR<sup>®</sup>**

## COUNTER DOOR



### PROPER APPLICATION

Door Type	Operator Type	Max Door Weight/HP
Rolling Steel Counter Door	Counter Door	1/2HP = 500 lbs.

### FOR LIGHT DUTY USE ONLY.

TO PREVENT THE MOTOR PROTECTOR FROM TRIPPING,  
DO NOT EXCEED 4 DOOR OPERATIONS PER HOUR.

## NOT FOR RESIDENTIAL USE

**This Installation Manual provides the information required to install, troubleshoot and maintain a CDX<sup>®</sup> Counter Door Operator.**

THIS PAGE LEFT BLANK

# Table of Contents

<b>Section 1</b>	<b>How to use this manual</b> .....	<b>1.1</b>	<b>Section 7</b>	<b>Special Operational Features</b> .....	<b>7.1-7.4</b>
<b>Section 2</b>	<b>Safety Information &amp; Instructions</b> .....	<b>2.1-2.2</b>		Operator Cycle Count .....	7.1
<b>Section 3</b>	<b>Critical Installation Information</b> .....	<b>3.1-3.4</b>		GDO & Display Firmware .....	7.1
<b>Section 4</b>	<b>Installation</b> .....	<b>4.1-4.4</b>		Operator Type .....	7.2
	Mounting .....	4.1-4.2		Optional Hand Crank .....	7.3-7.4
	Manual Release .....	4.3	<b>Section 8</b>	<b>Troubleshooting</b> .....	<b>8.1-8.5</b>
	Optional Timer-Close or Aux. Output Modules .....	4.4		Display Operation .....	8.1
<b>Section 5</b>	<b>Wiring</b> .....	<b>5.1-5.13</b>		Error Codes .....	8.1-8.2
	Safety Information/ Line Voltage Wiring .....	5.1-5.2		Run Codes .....	8.2-8.3
	Low Voltage Control Wiring .....	5.3		LED Indicators .....	8.4
	External Wire Diagram .....	5.4		Safe-T-Beam® Self-Diagnostic Troubleshooting Chart .....	8.5
	Wall Control .....	5.5-5.6	<b>Section 9</b>	<b>Service &amp; Maintenance</b> .....	<b>9.1</b>
	Monitored/Non-monitored Photocells .....	5.7		Periodic Maintenance Schedule .....	9.1
	Monitored/Non-monitored Sensing Edge .....	5.8-5.9	<b>Section 10</b>	<b>Appendixes</b> .....	<b>10.1-10.7</b>
	Locking Bottom Bar / Interlock Switch .....	5.10		Appendix A .....	10.1-10.3
	External Radio .....	5.11		Operator Parts Breakdown (Exploded View) .....	10.1
	Important Safety Information .....	5.12-5.13		Release Parts Breakdown .....	10.2
<b>Section 6</b>	<b>Operator Setup Procedures</b> .....	<b>6.1-6.8</b>		Circuit Board Breakdown .....	10.3
	Control Panel .....	6.1		Appendix B .....	10.4
	Setting Close Direction .....	6.2		Screw Terminal Assignments .....	10.4
	Setting Travel Limits .....	6.3		Appendix C .....	10.5-10.7
	Setting Limit Overrun .....	6.4		Run Codes .....	10.5
	Setting Open & Close Modes .....	6.5		Error Codes .....	10.6-10.7
	Setting Mid-Stop Limit .....	6.6	<b>Section 11</b>	<b>Warranty</b> .....	<b>11.1</b>
	Resetting the MRT .....	6.7			
	Monitored Reversing Devices .....	6.8			

# Section 1: How to use this manual

The 11 sections of this Installation Manual provide the information required to install, troubleshoot and maintain an CDX® commercial/industrial door operator.

## Section 2

Provides important defining information related to safety terminology used throughout this manual, as well as safety related instructions which must be followed at all times while doing any steps/tasks/instructions detailed in this manual.

## Section 3

Details pre-installation concerns/issues/decisions that are recommended to be considered and/or resolved prior to beginning any commercial door operator installation.

### **WARNING**

**Failure to correctly perform all steps in sections 4-6 can result in serious injury or death.**

### **AVERTISSEMENT**

**Ne pas effectuer correctement toutes les étapes dans les sections 4-6 peut entraîner des blessures graves voire la mort.**

## Sections 4-6

Provide step by step installation and set-up instructions for the CDX® commercial door operator. Each section is written such that it must be followed in a step by step order to complete a successful installation.

## Sections 7-8

Detail important features and troubleshooting information for typical installation and normal operations that may occur.

## Sections 9-11

Provide related information on service and maintenance items, operator drawings for use in troubleshooting and service activities, along with important warranty and returned goods policy information.



## Section 2: Safety Information & Instructions

### **WARNING**

Overhead Doors are large, heavy objects that move with the help of springs under high tension and electric motors. Since moving objects, springs under tension, and electric motors can cause injuries, your safety and the safety of others depend on you reading the information in this manual. If you have any questions or do not understand the information presented, call your nearest service representative. For the number of your local Overhead Door Dealer, call 800-929-3667, and for Overhead Door Factory Technical Advice, call 800-275-6187.







In this Manual, the words Danger, Warning, and Caution are used to stress important safety information. The word:

 **DANGER** indicates an imminently hazardous situation which, if not avoided, will result in death or serious injury.

 **WARNING** indicates a potentially hazardous situation which, if not avoided, could result in death or serious injury.

 **CAUTION** indicates a potentially hazardous situation which, if not avoided, may result in injury or property damage.

The word **NOTE** is used to indicate important steps to be followed or important considerations.

POTENTIAL HAZARD	EFFECT	PREVENTION
 <b>MOVING DOOR</b>	 <b>WARNING</b> Could result in Serious Injury or Death	<b>Do Not</b> operate unless the doorway is in sight and free of obstructions. Keep people clear of opening while door is moving. <b>Do Not</b> allow children to play with the door operator. <b>Do Not</b> change operator control to momentary contact unless an external reversing means is installed. <b>Do Not</b> operate a door that jams or one that has a broken spring
 <b>ELECTRICAL SHOCK</b>	 <b>WARNING</b> Could result in Serious Injury or Death	Turn off electrical power before removing operator cover. When replacing the cover, make sure wires are not pinched or near moving parts. Operator must be electrically grounded.
 <b>HIGH SPRING TENSION</b>	 <b>WARNING</b> Could result in Serious Injury or Death	<b>Do Not</b> try to remove, repair or adjust springs or anything to which door spring parts are fastened, such as, wood block, steel bracket, cable or any other structure or like item. Repairs and adjustments must be made by a trained service representative using proper tools and instructions.

## IMPORTANT

### READ PRIOR TO ANY DOOR OPERATION

1. Read manual and warnings carefully.
2. Keep the door in good working condition. Periodically lubricate all moving parts of door.
3. If door has a sensing edge, check operations monthly. Make any necessary repairs to keep it functional.
4. AT LEAST twice a year, manually operate door by disconnecting it from the operator. The Door should open and close freely. If it does not, the door must be taken out of service and a trained service representative must correct the condition causing the malfunction.
5. The Operator Motor is protected against overheating by an internal thermal protector. If the operator ceases to function because motor protector has tripped, a trained service technician may need to correct the condition which caused the overheating. When motor has cooled, thermal protector will automatically reset and normal operation can be resumed.
6. In case of power failure, the door can be operated manually by pulling the release cable to disconnect the operator drive system.
7. Keep instructions in a prominent location near the pushbutton.

## Section 2: Safety Information & Instructions




### **⚠️ AVERTISSEMENT**

Les portes basculantes sont de gros objets lourds qui fonctionnent à l'aide de ressorts soumis à une haute tension et de moteurs électriques. Dans la mesure où les objets en mouvement, les ressorts sous tension et les moteurs électriques peuvent entraîner des blessures, votre sécurité et celle des autres exigent que vous preniez connaissance des informations stipulées dans ce manuel. Si vous avez des questions ou si vous ne comprenez pas les informations ci-incluses, veuillez contacter le représentant de service le plus près. Pour obtenir le numéro du revendeur Overhead Door local, appelez le +1 (800) 929-3667, et pour obtenir des conseils techniques de l'usine Overhead Door, appelez le +1 (800)-275-6187.

Dans ce manuel, les mots Danger, Avertissement, et Attention sont utilisés pour faire ressortir d'importantes informations relatives à la sécurité. Le mot :

- ⚠️ DANGER** signale une situation dangereuse imminente qui si elle n'est pas évitée, risque d'entraîner des blessures graves, voire mortelles.
- ⚠️ AVERTISSEMENT** signale une situation potentiellement dangereuse qui, si elle n'est pas évitée, risque d'entraîner la mort ou des blessures graves.
- ⚠️ ATTENTION** signale une situation potentiellement dangereuse qui, si elle n'est pas évitée, risque d'entraîner des blessures ou des dommages matériels.

Le terme **REMARQUE** est utilisé pour signaler les étapes importantes à suivre ou d'importants éléments à prendre en considération.

DANGER POTENTIEL	EFFET	PRÉVENTION
 <b>PORTE EN MOUVEMENT</b>	<b>⚠️ AVERTISSEMENT</b> <b>Pourrait entraîner des blessures graves voire la mort</b>	Utiliser uniquement si la porte est en vue et libre de tout obstacle. Ne laisser personne se tenir dans l'ouverture de la porte pendant qu'elle est en mouvement. Ne pas permettre aux enfants de jouer avec l'opérateur de la porte. Ne pas modifier la commande de l'opérateur à contact momentané à moins qu'un moyen d'inversion externe soit installé. Ne pas faire fonctionner une porte qui bloque ou dont le ressort est cassé.
 <b>CHOC ÉLECTRIQUE</b>	<b>⚠️ AVERTISSEMENT</b> <b>Pourrait entraîner des blessures graves voire la mort</b>	Couper le courant avant d'enlever le couvercle de l'opérateur. Lorsque le couvercle doit être remplacé, s'assurer que les fils ne sont ni coincés ni près des pièces mobiles. L'opérateur doit être correctement mis à la terre.
 <b>TENSION ÉLEVÉE DU RESSORT</b>	<b>⚠️ AVERTISSEMENT</b> <b>Pourrait entraîner des blessures graves voire la mort</b>	Ne pas essayer d'enlever, réparer ni ajuster les ressorts ou toute autre pièce à laquelle le ressort de la porte est attaché, y compris blocs de bois, supports en acier, câbles ou autres articles semblables. Les réparations et les réglages doivent être effectués par technicien qualifié qui se sert d'outils appropriés et qui respecte les instructions.

## Section 3: Critical Installation Information

### Job Site Issues to Consider/Concerns

The following list of items should be considered prior to selecting an operator for a given job site.

1-Available power supply. 2-Type of door. 3-Potential operator mounting obstructions. Items to consider include, but are not limited to: side room, room above door shaft, room below door shaft, available mounting surface integrity, power supply location, and convenient chain hoist and release cable positioning. 4-Size of door for appropriate operator torque and door travel speed selection. 5-Operator mounting environment. Items to consider include operator location, dampness of location, dustiness of the location and corrosiveness of the location. 6-Door activation needs/requirements. Examples include 3 button control stations, 1 button control stations, radio controls, pull cords, loop detectors, photoelectric controls, key switches, etc. See "Entrapment Protection" section below. 7-Interlock switches are required under certain conditions for doors with pass doors and door locks. See Section 5. 8-Accessory equipment. Examples include reversing edges and/or photocell beams, which are required for doors set to operate as momentary contact, auxiliary control relays, warning lights, etc.

See "Entrapment Protection" section below.


#### ENTRAPMENT PROTECTION

The installation of a fail safe external reversing device (such as a monitored reversing edge or photocell system, etc.) is required on all momentary contact electronically operated commercial doors. If such a reversing device is not installed, the operator will revert to a constant contact control switch for operation (Closing only).

The Reversing Devices currently UL Approved are:

- 1) MillerEdge ME and MT series monitored edge sensors used in combination with Timer-Close Module P/N OPABTCX.S
- 2) MillerEdge ME and MT series monitored edge sensors used in combination with MillerEdge Interface Module OPAKMEIGX.S. (Direct connect through STB inputs.)
- 3) MillerEdge Wireless monitored edge sensor OPAKMMWE.S.
- 4) Residential Safe-T-Beam® Monitored Photocells - P/N 37221R (OSTB-BX) and 38176R.S (includes extension brackets).
- 5) Series II Commercial Safe-T-Beam® Monitored Photocells - P/N OPAKPE.S and OPAKPEN4GX.S (NEMA 4).
- 6) Monitored Retro-Reflective Photoeye - P/N OPRAKRPEN4X.S

 **WARNING:** DO NOT apply line voltage until instructed to do so.

 **AVERTISSEMENT:** NE PAS mettre sous tension tant que l'instruction n'est pas donnée de le faire.

## Section 3: Critical Installation Information

**⚠ CAUTION:** Check working condition of door before installing the operator. Door must be free from sticking and binding. If equipped, deactivate any door locking device(s). Door repairs and adjustments, including cables and spring assemblies **MUST** be made by a trained service representative using proper tools and instructions.

**⚠ ATTENTION:** Vérifiez l'état de fonctionnement de la porte avant d'installer l'opérateur. La porte doit pouvoir bouger librement et ne pas coincer. Désactivez tous les dispositifs de verrouillage de la porte (si équipés). Les réparations et les réglages de porte, plus particulièrement pour les câbles et les ressorts **DOIVENT** être effectués par un technicien qualifié qui se sert d'outils appropriés et qui respecte les instructions.

## ENTRAPMENT PROTECTION

The CDX® can be used with the following UL Approved entrapment devices in compliance with UL325 requirements active starting August 29, 2010.

UNTIL ONE OF THESE MONITORED EXTERNAL ENTRAPMENT DEVICES IS INSTALLED, THE CDX® WILL NOT ALLOW MOMENTARY CONTACT OPERATION IN THE CLOSE DIRECTION.

LISTED DEVICES	ALLOWABLE DOOR WIDTH
MillerEdge ME & MT series monitored edge sensors used in combination with OPABTCX.S Timer-Close Module or MillerEdge Interface Module OPAKMEIGX.S. MillerEdge Wireless monitored edge sensor OPAKMMWE.S	ANY WIDTH
Residential Safe-T-Beams® P/N 37221R (OSTB-BX) and 38176R.S (includes ext. brkt's)	30 FEET
Commercial Photoeye Kit P/N OPAKPE.S and OPAKPEN4GX.S (NEMA 4)	
Monitored Retro-Reflective Photoeye Kit P/N OPRAKRPEN4X.S	35 FEET

			Rolling Steel Door Chart (Sq. Ft.)									Counter Doors	Grilles	
Model	HP	UL/CSA Listed	600	610/620			615/616	625				650/651/652	670	671
			Coilaway	22GA.	20GA.	18GA.	24GA.	24GA.	22GA.	20GA.	18GA.	22GA/Alum	Aluminum	Steel
CDX®	1/2	YES	256	125	107	104	267	N/A	N/A	N/A	N/A	ALL	238	150

**Note:** Total door weight, and not the square footage, is the critical factor in selecting the proper operator. Square foot measurements are based on "square doors". (Example = 16' x 16')

**Note:** Doors that require special windloading and wide doors normally require increased strutting (reinforcement). Strutting doors can significantly increase door weight beyond maximum weight shown. Consult factory personnel in these situations.

### Section 3: Critical Installation Information

## **IMPORTANT INSTALLATION INSTRUCTIONS**

### **WARNING-** To reduce the risk of severe injury or death:

- 1) READ AND FOLLOW ALL INSTALLATION INSTRUCTIONS.
- 2) Install only on a properly operating and balanced door. A door that is operating improperly could cause severe injury. Have qualified service personnel make repairs to cables, spring assemblies and other hardware before installing the operator.
- 3) Remove all pull ropes and remove, or make inoperative, all locks (unless mechanically and/or electronically interlocked to the power unit) that are connected to the door before installing the operator.
- 4) Install the door operator at least 8 feet above the floor if the operator has exposed moving parts.
- 5) Do not connect the door operator to the power source until instructed to do so.
- 6) Locate the control station: (a) within sight of the door, (b) a minimum of 5 feet above the floor so that small children cannot reach it, and (c) away from all moving parts of the door.
- 7) Install the Entrapment Warning Placard next to the control station and in a prominent location.
- 8) For products having a manual release, instruct the end user on the operation of the manual release.

## **IMPORTANT INSTRUCTIONS D'INSTALLATION**

### **AVERTISSEMENT-**

### Pour réduire les risques de blessures graves ou de mort :

- 1) LIRE ET RESPECTER TOUTES LES INSTRUCTIONS D'INSTALLATION.
- 2) Installez uniquement sur une porte fonctionnant correctement et bien équilibrée. Une porte qui fonctionne mal peut provoquer des blessures graves. Demandez à un technicien qualifié d'effectuer les réparations des câbles, des ressorts et de toute autre quincaillerie avant de procéder à l'installation de l'opérateur.
- 3) Retirez toutes les cordes de traction ainsi que tous les verrous ou rendez-les inopérants (à moins qu'ils ne soient mécaniquement et/ou électroniquement interverrouillés à l'unité motrices) qui sont connectés à la porte avant de procéder à l'installation de l'opérateur.
- 4) Installez l'opérateur de la porte à 2,4 m minimum au-dessus du sol lorsque des pièces mobiles de l'opérateur sont exposées.
- 5) Ne pas raccorder l'opérateur de la porte à la source d'alimentation avant que l'instruction ne soit donnée de le faire.
- 6) Installez la station de commande : (a) en vue de la porte, (b) à 1,5 m minimum au-dessus du sol pour que les jeunes enfants ne puissent pas l'atteindre, et (c) à l'écart de toutes les pièces mobiles de la porte.
- 7) Installez le poster d'avertissement de pincement à côté de la station de commande à un endroit bien en vue.
- 8) Pour les produits ayant un déclenchement manuel, indiquez à l'utilisateur comment déclencher manuellement.

## Section 4: Installation

### Mounting

Unless otherwise stated, these instructions will show right side mount installations. Left side mount is opposite.

- 1) Insert four(4) 3/8"-16 x 1" carriage bolts into headplate. **FIG. 1.**
  - Threads to outside of plate.
  - Retain by pushing 4 speed nuts onto bolts.
- 2) Complete installation of door as instructed in door installation manual up to "mounting of hood."
- 3) Make certain both headplates are at 90° to wall.
  - If not at 90°, use temporary external brace to hold in place.
- 4) Install hood and secure with hood mounting screws.
  - When hood is secure, remove temporary brace if used (step3).
  - Leave door in FULL OPEN position.
- 5) Place 3/8" flat washers and 3/8"-16 keps nuts on 3/8" carriage bolts closest to wall.
  - Leave nuts flush with ends of nuts.
- 6) Remove chain guard and front cover from CDX® operator.

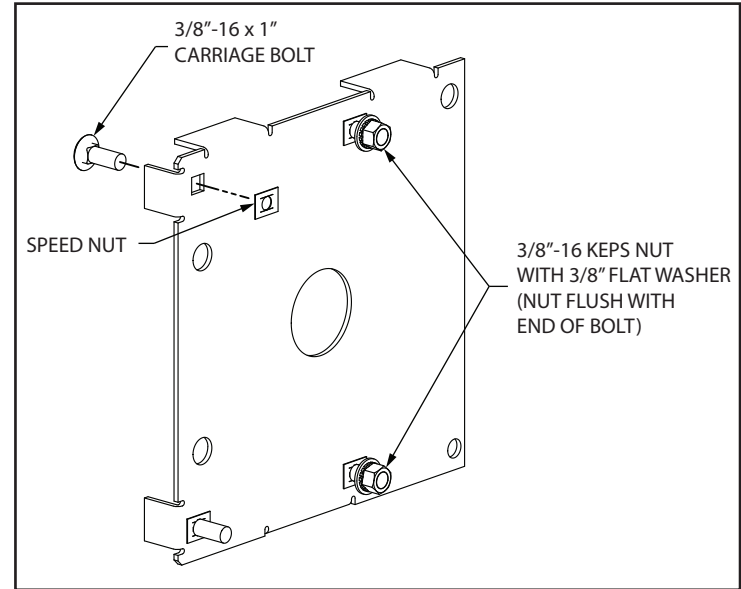


Figure 1

## Mounting (continued)

- 7) Slide open ended slots of CDX® frame under flat washers installed in step 5. **FIG. 2.**
  - Locate other frame slots over remaining two(2) carriage bolts and bring frame against headplate.
  - Put 3/8" washers and keps nuts on remaining bolts.
  - DO NOT fully tighten nuts.
  - Slide operator toward wall as far as slots allow.
- 8) Place driven sprocket and key on door shaft and align with output sprocket on operator.
  - Secure sprocket and key in place with set screws.
- 9) Wrap #41 roller chain around both sprockets and join with connecting link. **FIG. 3.**
  - Extra chain may need to be added depending on size of headplate.
  - Slide operator away from hood until drive chain is tensioned *but not tight*.
  - Tighten mounting nuts.

Figure 2

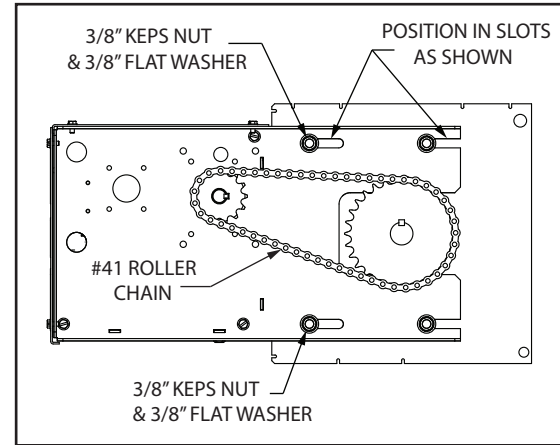
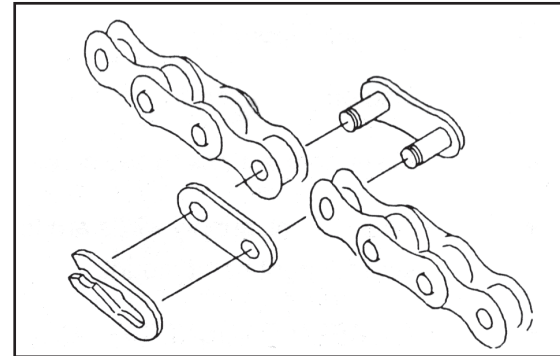


Figure 3



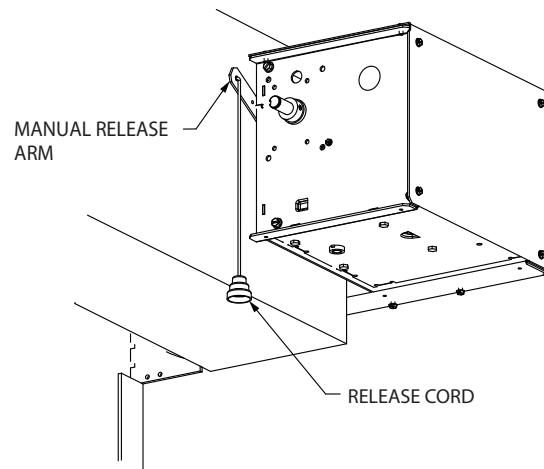


## Manual Release

**NOTE:** In case of power failure, door can be operated manually.

CDX® operator can be disconnected from door by pulling red pull rope attached to Manual Release Arm to allow opening door. **FIG. 4**

- When door is in manual operation, limit switch setting is not affected.
- Releasing pull rope will re-engage operator.



**Figure 4**

## Optional Timer-Close Module or Auxiliary Output Module

These instructions apply to either board. Although they perform different functions, they mount in the same way.

- 1) Remove four (4) self-tapping screws from front panel of CDX® enclosure and remove front panel to expose control circuits. **FIG. 5.**
- 2) Orient the module so mounting bracket tabs are to the left and wire terminals are facing up.
- 3) Make desired wiring connections, in accordance with instruction manual accompanying the module.
- 4) Insert module into the area indicated and slide front mounting tab into slot on side panel of CDX® enclosure. **FIG. 6 & 7.**
- 5) Adjust module so that it is level with CDX® enclosure.
  - There is a mounting hole on side panel of enclosure which will line up with hole in module mounting bracket.
  - Attach module by inserting self-tapping screw (provided in kit) through module bracket and into hole in side panel. Do not overtighten.
- 6) Replace front panel.

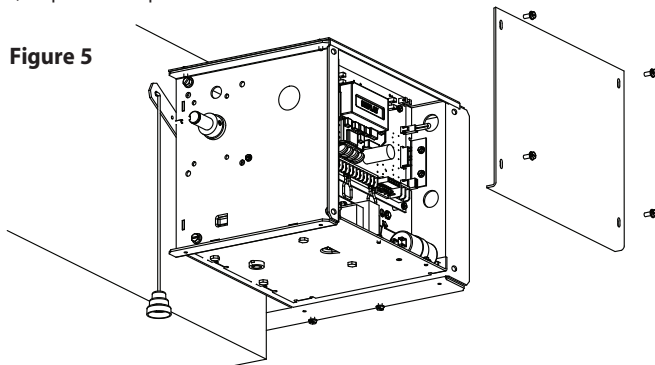


Figure 5

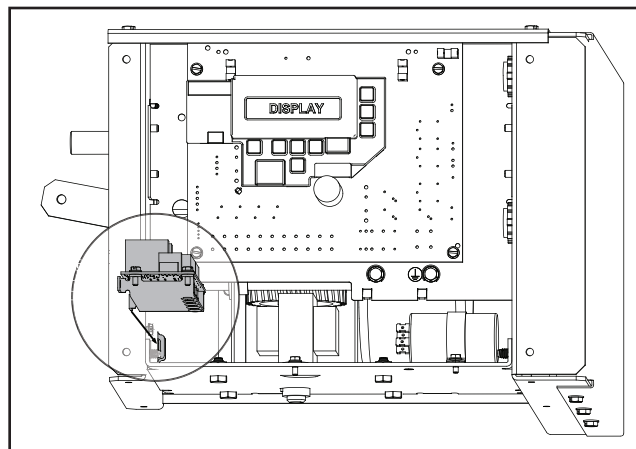


Figure 6

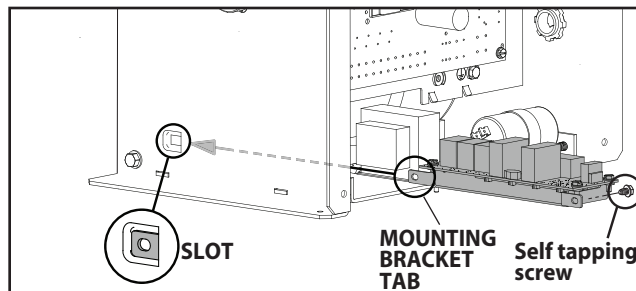


Figure 7

## Section 5: Wiring

### **⚠ WARNING**

- DO NOT apply power to operator until instructed to do so.
- It is strongly recommended, and may be required by law in some areas, that line voltage wiring be performed by a qualified electrician.
- Be sure that electrical power has been disconnected from the input power wires being connected to the operator prior to handling these wires. An appropriate lock-out/tag-out procedure is recommended.
- Line voltage wiring must meet all local building codes.
- Make sure operator voltage, phase and frequency nameplate ratings are identical to the job site line voltage ratings.
- Input power wiring must be properly sized for the operators amperage rating located on the nameplate.
- To reduce the risk of electric shock, make sure the chassis of this unit is properly grounded.

### **⚠ AVERTISSEMENT**

- NE PAS mettre sous tension tant que l'instruction n'est pas donnée de le faire.
- Il est fortement recommandé voire même exigé par la loi dans certaines régions, de contacter un électricien qualifié pour l'acheminement du fil électrique.
- Assurez-vous que l'alimentation électrique a été déconnectée des câbles d'alimentation d'entrée connectés à l'opérateur avant de manipuler ces câbles. Une procédure de verrouillage/étiquetage appropriée est recommandée.
- Le câblage au secteur doit satisfaire à tous les codes de construction locaux.
- Assurez-vous que les valeurs nominales de la plaque signalétique pour tension, phase et fréquence de l'opérateur correspondent à celles des tensions de l'alimentation sur site.
- La capacité d'entrée doit correspondre à la valeur nominale de l'ampérage des opérateurs indiquée sur la plaque signalétique.
- Pour réduire le risque de choc électrique, assurez-vous que le châssis de l'unité est correctement mis à la terre.

## Line Voltage Wiring Fig. 1

- 1) Remove LINE VOLTAGE INPUT PLUG and install proper fittings and 1/2" conduit.
- 2) Route proper LINE VOLTAGE wires into operator.
- 3) Locate LINE INPUT terminals on circuit board. Using correct connectors, attach wires to LINE INPUTS, and GROUND terminal.
  - Keep low voltage and line voltage wires separate.
  - Route all line voltage wires as shown.
  - Plug all unused conduit holes.

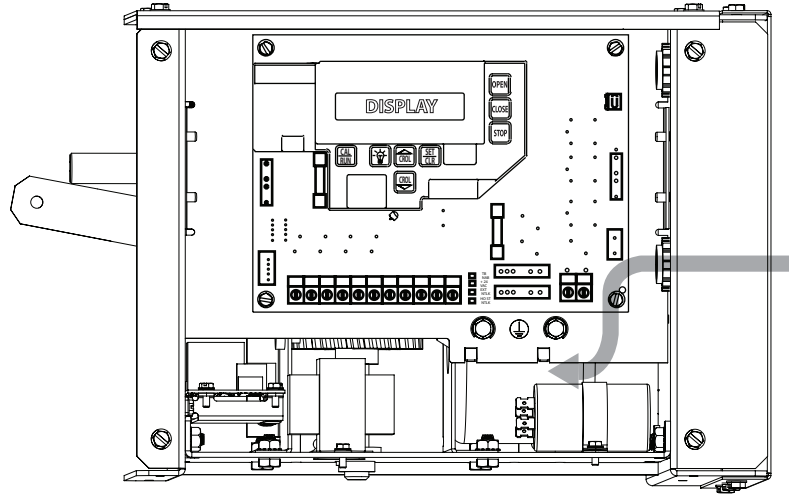
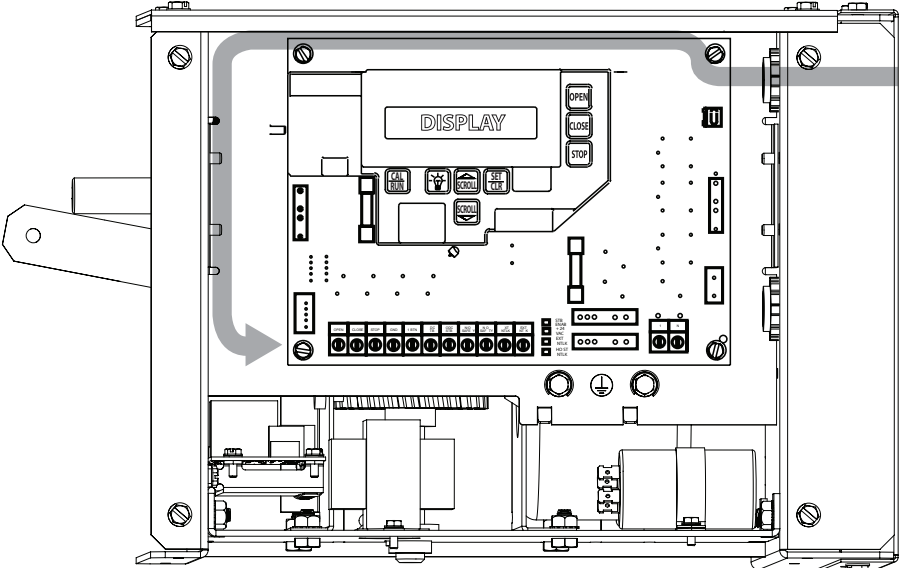


Figure 1

# Low Voltage Control Wiring Fig. 2

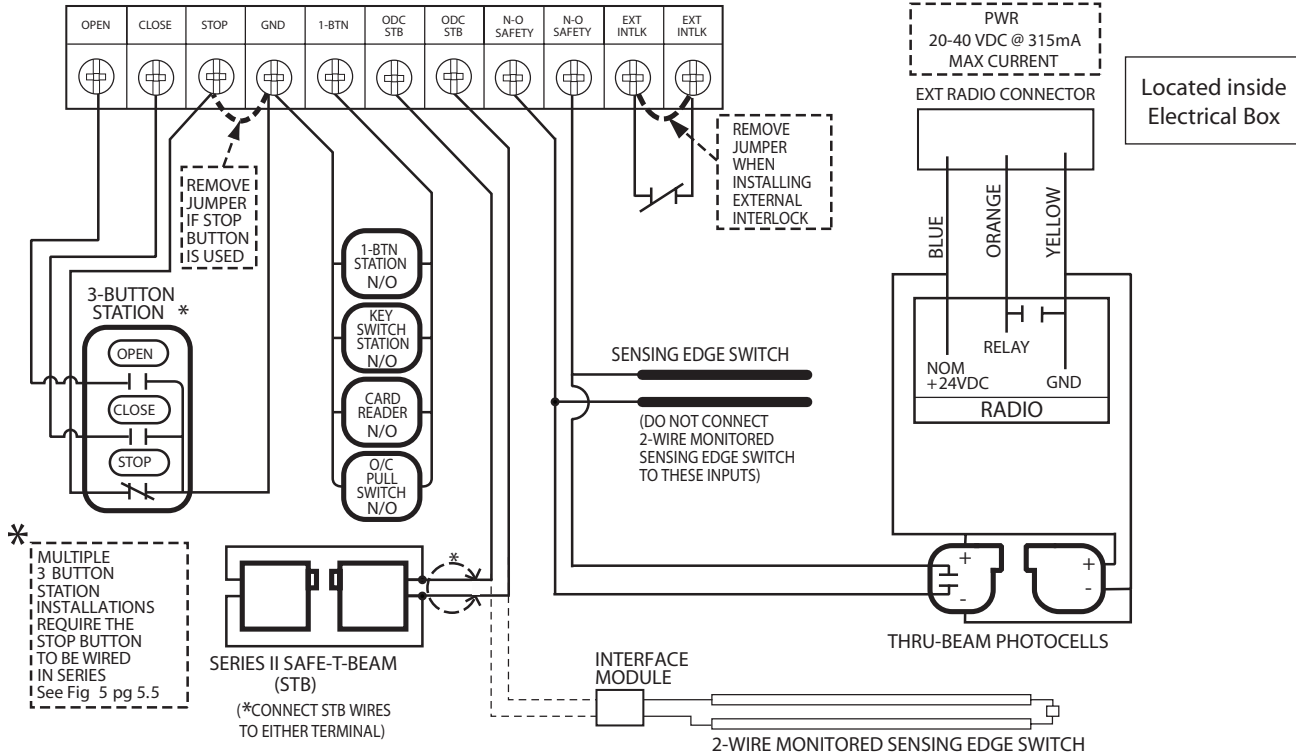
- 1) Connect all LOW VOLTAGE control circuit wires to this side of unit using 1/2" conduit or flexible convoluted tubing.
  - Keep low voltage and line voltage wires separate.
  - Route all low voltage control wiring as shown. This includes all control circuit wires such as wall controls, timers and single button input devices as well as radio control and safety circuit wiring.
  - Plug all unused conduit holes.

Figure 2



# External Wire Diagram

See Appendix B for detailed description of terminals.



## Wall Control

- 1) For a single 3 - button installation, make connections as shown in **Fig. 3**.

### **⚠ WARNING:**

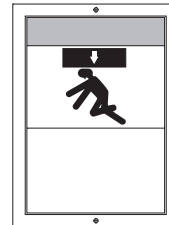
- Wall Control(s) must be located so that the door is within sight of the user and is far enough from the door, or positioned such that the user is prevented from coming in contact with the door while operating controls.
- Attach the Warning placard adjacent to the Wall Control. **Fig. 3A**.
- Attach the Caution label adjacent to the Wall Control. **Fig. 3B**.

### **⚠ AVERTISSEMENT:**

- La ou les commandes murales doivent être situées de telle sorte que l'utilisateur puisse voir la porte et positionnées de telle sorte que l'utilisateur ne puisse pas entrer en contact avec la porte lorsqu'il se sert des commandes.
- Fixez le poster d'avertissement à côté de la commande murale. **Fig. 3A**
- Fixer l'étiquette de mise en garde (Attention) à côté de la commande murale. **Fig. 3B**.

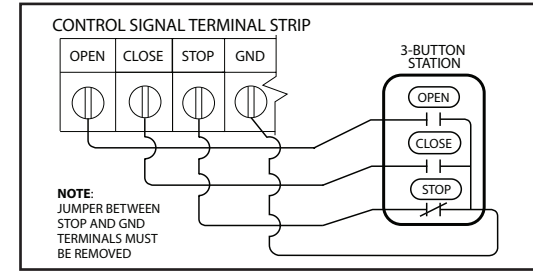
**⚠ WARNING:** Before momentary contact control can be used on the CLOSE button, a monitored external reversing device such as a photocell system or sensing edge switch must be used. See pages 5.7-5.9 for installation of entrapment protection devices.

**⚠ AVERTISSEMENT:** Avant d'utiliser la commande à contact momentané sur le bouton FERMETURE, un dispositif d'inversion externe surveillée tel qu'un système de cellule photoélectrique ou un commutateur de détection de bord doit être utilisé. Voir l'installation des dispositifs de protection contre le coincement en pages 5.7-5.9.



Entrapment  
Warning Placard

**Figure 3A**



**Figure 3**

### **CAUTION**

To prevent the motor protector from tripping, do not exceed 4 door operations per hour. For light-duty use ONLY.

**NOT FOR RESIDENTIAL USE**

### **ATTENTION**

Pour parer au déclenchement du système de protection du moteur, NE PAS dépasser 4 opérations de la porte à l'heure.

Pour service simple UNIQUEMENT.

**NON DESTINÉ POUR USAGE RÉSIDENTIEL.**

**Figure 3B**

## Wall Control (cont.)

- 2) For single button accessory controls, make connections as shown in **Fig. 4**.
- 3) For a multiple 3 - button installations, make connections as shown in **Fig. 5**.

**NOTE:** If an External STOP button is NOT being installed, a jumper wire must be installed between the "STOP" AND "GND" terminals as shown.

**NOTE:** Long Distance Relay Kit wiring is not required for long distance control runs and should not be used

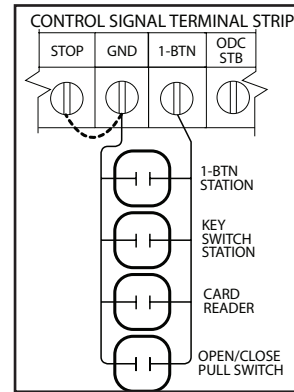


Figure 4

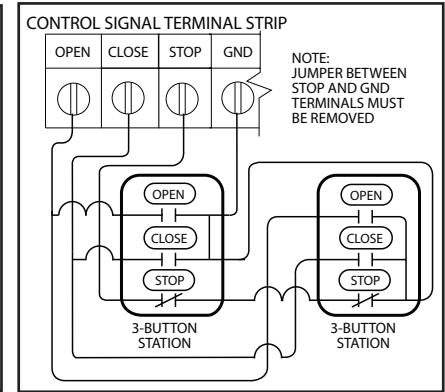


Figure 5



# Photocell Wiring

## Series II Safe-T-Beam® Monitored Photocells

- 1) Monitored SERIES II (STB) photocells (P/N OPAKPE.S) and Residential Safe-T-Beam® Monitored Photocells from Overhead Door® (P/N 37221R & 38176R.S). **Fig. 6.** Wiring to these photocells can be connected to either terminal (they are not polarity sensitive.) (**Troubleshooting in Section 8**)

**NOTE:** Installer must enable ODC STB in calibration mode. See page 6.8.

**⚠ WARNING:** Actuating the operator by using constant contact on the CLOSE button will override non-functioning external reversing devices, including photocells.

**⚠ AVERTISSEMENT:** L'activation de l'opérateur en utilisant un contact constant sur le bouton FERMER annulera les dispositifs d'inversions externes, y compris les cellules photoélectriques.

- 2) **To Mount Photocells:** (Kit includes detailed Instructions).
  - Determine location for mounting. They do not need to be directly adjacent to the door but must be somewhere along the wall where there will be an unobstructed line between them. **Fig. 8.**
  - They must extend out away from the wall sufficiently that no door hardware breaks the plane of the photo-beam.

**⚠ WARNING:** Photocell systems provide entrapment protection when mounted near the doorway in such a way that the lower portion of an individual's leg will break the photocell beam during normal walking conditions.

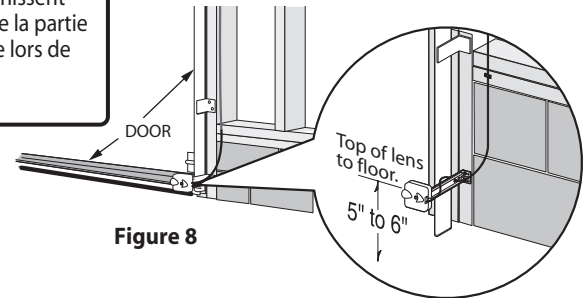
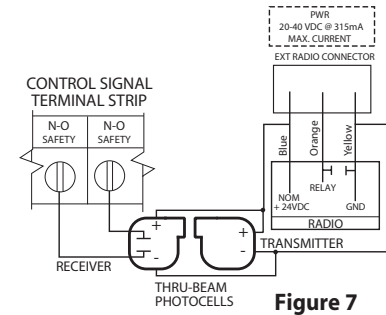
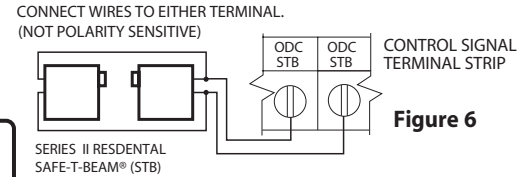
**⚠ AVERTISSEMENT:** Les systèmes de cellules photoélectriques fournissent une protection contre le coincement pour le montage à proximité de la porte de manière à ce que la partie inférieure de la jambe d'un individu ne puisse pas rompre le faisceau de la cellule photoélectrique lors de passages normaux par la porte.

## Commercial Non-Monitored Photocells

- 1) Nominal 24 Volt DC Commercial photocells with normally open contacts can be connected as shown in **Fig. 7.**

**NOTE:** Blue wire supplies 20 – 40VDC. Photocells used must be compatible with this voltage range.

**NOTE:** If no voltage is present at Blue wire, check fuse F-1 on Control board.



## Sensing Edge Installation

**Figure 10** shows an example of a typical sensing edge installation. Left hand side is shown but right hand is a mirror image of this.

- 1A) If the wiring from the sensing edge enclosure to the operator is a coiled cord or 2 wire jacketed cord:
  - Install junction box 12" above the center of the door opening on same side as sensing edge enclosure.
  - Secure one end of cord to junction box using a cable clamp.
- 1B) If connection is to be made through a take up reel cord:
  - Install on same side as sensing edge enclosure and above door opening and slightly to the side.
  - Install junction box adjacent to take up reel and route the stationary cord from the reel to the box and secure with a cable clamp.

**NOTE:** DO NOT USE TAKE UP REEL IF INSTALLING A 2 WIRE MONITORED EDGE.

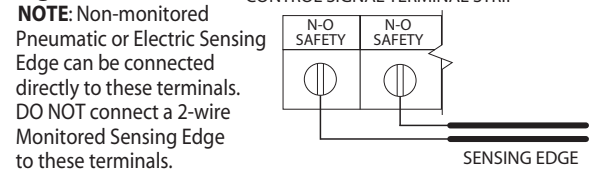
- 2) Secure other end of cord (straight, coiled or reel) to sensing edge enclosure using a cable clamp.
- 3) Connect wires of cord to sensing edge using wire nuts or other suitable wire connectors.
- 4) Run a straight 2 wire cord from the junction box (Step 1) to the operator electrical box.
  - Secure using cable clamp on each end.
- 5) Join wires in cord from operator to wires in cord from junction box using wire nuts or other suitable wire connectors.
- 6A) **Non-Monitored** sensing edge connects to terminal strip on main board using (N-O SAFETY) terminals. See **Fig. 9A**.
- 6B) **Monitored** sensing edge connects to Timer-Close Module terminals (MON EDGE and GND) or to (ODC STB) terminals on main board through a Miller Edge Interface Module as shown in **Fig. 9B**.

**⚠ WARNING:** Actuating the operator using constant contact on the CLOSE button will override non-functioning external reversing devices, including sensing edges.

**⚠ AVERTISSEMENT:** L'activation de l'opérateur avec un contact constant sur le bouton FERMER annulera les dispositifs de renversement externes non fonctionnels, y compris les systèmes de détection des bords.

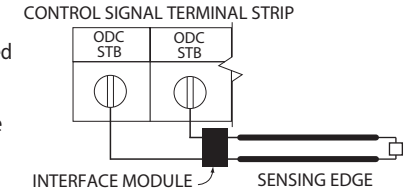
Continued on next page.

**Figure 9A**

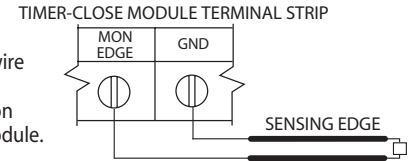


**Figure 9B**

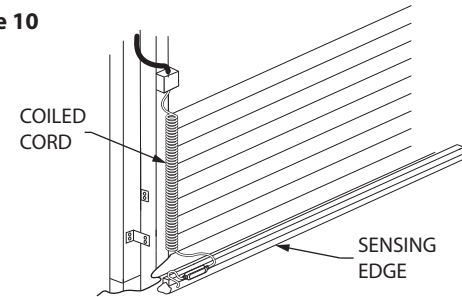
**NOTE:** 2-wire Monitored Sensing Edge must be connected through the MillerEdge Interface Module.



**NOTE:** Monitored 2-wire Sensing Edge can also be used in combination with a Timer-Close Module.



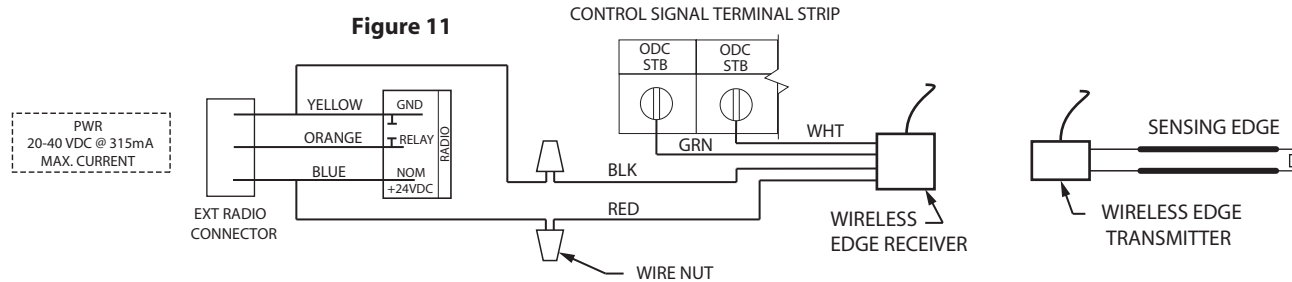
**Figure 10**



## Sensing Edge Installation (continued)

- 7) Operate the door to make certain cord is free to travel and does not become snared during door opening or closing.
  - Check sensing edge for proper operation.
- 8) While the door is closing actuate the sensing edge to verify the door reverses to open limit.

Figure 11 shows the connection of OPAKMMWE.S MEL Miller Edge Monitored Wireless Sensing Edge.



**⚠ WARNING:** To obtain proper operation of the MEL edge sensor, each transmitter/receiver set must be set to a unique address. Follow instructions provided with the Miller Edge MEL kit to set the address.

**⚠ AVERTISSEMENT:** Pour obtenir un fonctionnement correct du capteur de bord MEL, réglez chaque ensemble émetteur/récepteur sur une adresse unique. Suivez les instructions fournies avec le kit Miller Edge MEL pour définir l'adresse.

## Locking Bottom Bar / Interlock

Figure 12 shows an example of a typical locking bottom bar. Left hand side Interlock Switch is shown. Right hand mount is mirror image.

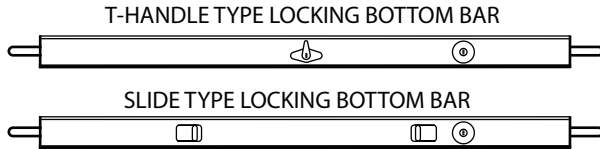
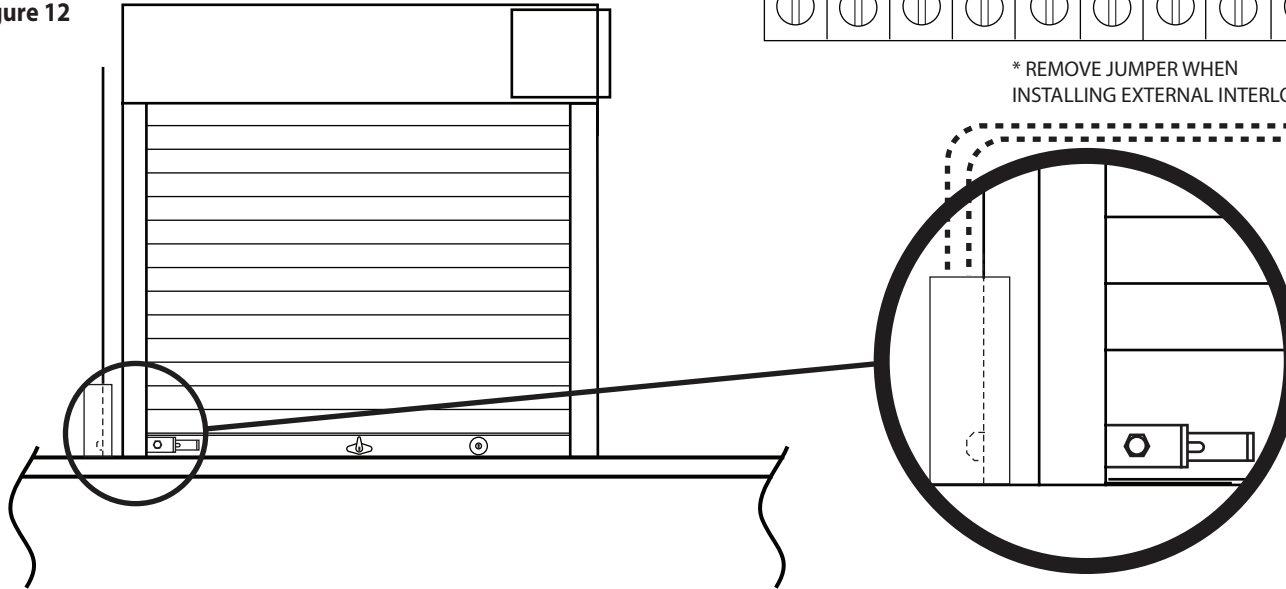


Figure 12



**NOTE:** Interlock Switch is mandatory on doors equipped with an electronically controlled commercial operator.

### CONTROL SIGNAL TERMINAL STRIP

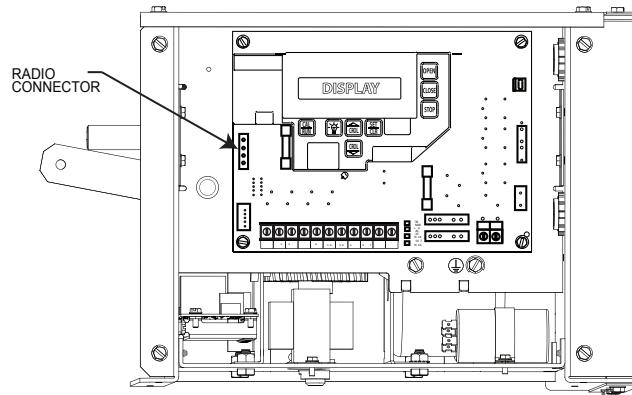
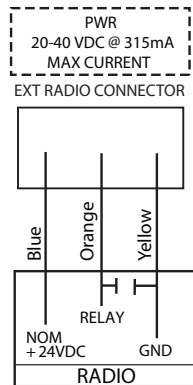
OPEN	CLOSE	STOP	GND	1 BTN	ODC STB	ODC STB	N O SAFETY	N O SAFETY	EXT INTLK	EXT INTLK

\* REMOVE JUMPER WHEN  
INSTALLING EXTERNAL INTERLOCK

## External Radio Installation

### To Add the External Radio

- 1) Plug the external radio harness (provided) onto the plug connector marked "RADIO," **Fig. 13**.
- 2) Make wiring connections to the receiver per the diagram below.



**Figure 13**

## Safety Instructions

# **IMPORTANT SAFETY INSTRUCTIONS**

**WARNING-**  
To reduce the risk of severe  
injury or death:

- 1) READ AND FOLLOW ALL INSTRUCTIONS.
- 2) Never let children operate or play with door controls. Keep the remote control (where provided) away from children.
- 3) Personnel should keep away from a door in motion and keep the moving door in sight until it is completely closed or opened. **NO ONE SHOULD CROSS THE PATH OF A MOVING DOOR.**
- 4) Test the door's safety features at least once a month. After adjusting either the force or the limit of travel, retest the door operator's safety features. Failure to adjust the operator properly may cause severe injury or death.
- 5) For products having a manual release, if possible, use the manual release only when the door is closed. Use caution when operating the release while the door is open. Weak or broken springs may cause the door to fall rapidly, causing severe injury or death.
- 6) **KEEP DOOR PROPERLY OPERATING AND BALANCED.** See Door Manufacturer's Owner's Manual. An improperly operating or improperly balanced door could cause severe injury or death. Have only trained door systems technicians make repairs to cables, spring assemblies, other hardware and any wooden blocks or like items to which they may be attached.
- 7) **SAVE THESE INSTRUCTIONS.**

## Safety Instructions (continued)

# CONSIGNES DE SÉCURITÉ IMPORTANTES

## AVERTISSEMENT- Pour réduire les risques de blessures graves ou de mort :

- 1) LIRE ET RESPECTER TOUTES LES INSTRUCTIONS.
- 2) Ne jamais permettre aux enfants d'actionner ni de jouer avec les commandes de la porte.  
Tenir les télécommandes (si fournies) hors de la portée des enfants.
- 3) Le personnel doit se tenir à l'écart d'une porte en mouvement et garder bien en vue une porte en mouvement jusqu'à ce qu'elle soit complètement fermée ou ouverte. **PERSONNE NE DOIT TRAVERSER LA TRAJECTOIRE D'UNE PORTE EN MOUVEMENT.**
- 4) Testez les fonctionnalités de sécurité de la porte au moins une fois par mois. Après avoir réglé la force ou la limite de la course, retestez les éléments de sécurité de l'opérateur de la porte. Un mauvais réglage de l'ouvre-porte peut entraîner des blessures graves voire la mort.
- 5) Pour les produits ayant un déclenchement manuel, dans la mesure du possible, utilisez le déclenchement manuel uniquement lorsque la porte est fermée. Prenez toutes les précautions nécessaires lors de l'utilisation du déclenchement manuel alors que la porte est ouverte. Des ressorts faibles ou brisés peuvent faire descendre la porte rapidement ce qui peut entraîner des blessures graves voire la mort.
- 6) **VEILLER À CE QUE LA PORTE SOIT CORRECTEMENT ÉQUILIBRÉE ET FONCTIONNE BIEN.** Consultez le manuel de l'utilisateur du fabricant de la porte. Une porte déséquilibrée ou fonctionnant incorrectement pourrait entraîner de graves blessures voire la mort. Seuls des techniciens formés sur systèmes de portes peuvent effectuer des réparations aux câbles, aux ressorts, aux autres matériels et aux blocs de bois ou éléments semblables auxquels ces éléments peuvent être attachés.
- 7) **CONSERVER CES CONSIGNES.**

## Section 6: Operator Setup Procedure

### Control Panel

CDX® Operators include a full function control panel including a liquid crystal display (LCD), calibration keys and Open, Close and Stop keys for on board operator control. See **Fig. 1**. The open, close and stop keys function as a 3-button wall control. The Display will show current operator conditions and calibration information. Due to limited character space, some displays will be abbreviated. See Appendix C (pgs. 10.5-10.7) for full display descriptions.

CDX® Operators include a non-volatile memory. The unit will remember all calibration settings plus error code and run code logs, if power is removed from unit.

**⚠ DANGER:** After power is supplied to the operator, **Do Not** make contact with components inside the control panel except for the Keypad Keys. **Fig. 1**.

**⚠ DANGER:** Après avoir mis l'opérateur sous tension, **NE PAS** entrer en contact avec des composants à l'intérieur du panneau de commande, sauf pour les touches du pavé numérique. **Fig. 1**.

**AFTER WIRING HAS BEEN COMPLETED, TURN ON POWER TO THE OPERATOR.**

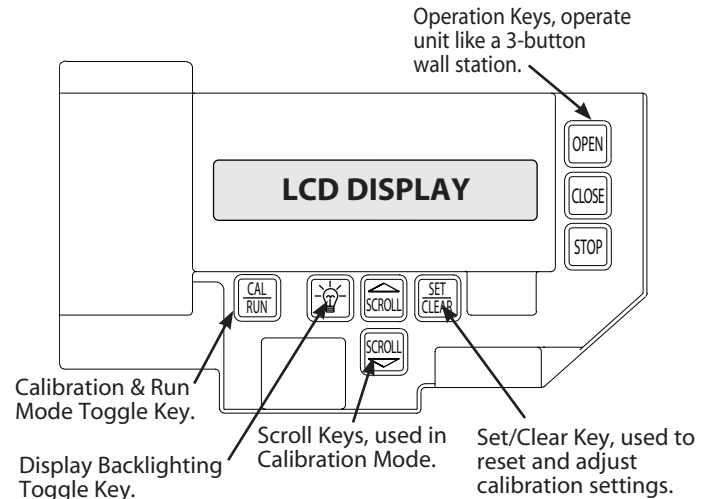
#### Control Operating Modes

CDX® Operator control boards operate in two modes: Run Mode and Calibration Mode. The control board should normally operate in the Run Mode. The operator is calibrated in Calibration Mode.

#### With the operator standing idle:

PRESS CAL/RUN TO TOGGLE BETWEEN OPERATING MODES.

- The first display in calibration mode is "SET CLOSE DIR."
- The display in run mode will be one of the condition codes listed in Appendix C.



**Figure 1**







**⚠ WARNING:** DO NOT calibrate operator or operate door unless doorway is in sight and free obstructions. Door will move during setup. Keep people clear of opening while door is moving.

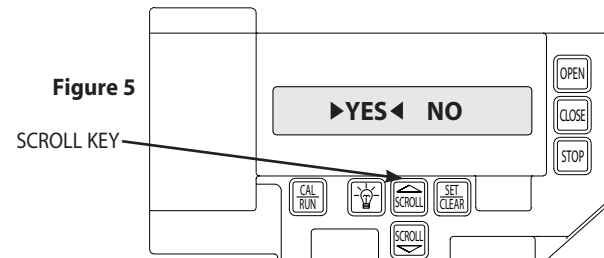
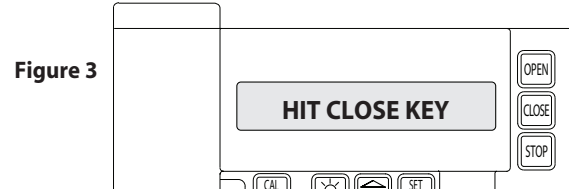
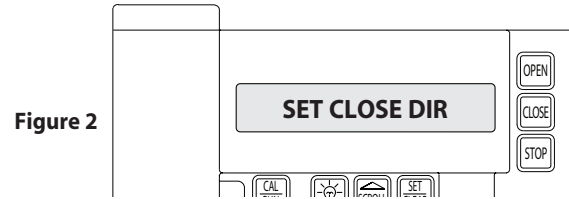
**⚠ AVERTISSEMENT:** Calibrer l'opérateur et utiliser la porte uniquement si la porte est en vue et libre de tout obstacle. La porte se déplacera pendant la programmation. Ne laisser personne se tenir dans l'ouverture de la porte pendant qu'elle est en mouvement.



## Setting Close Direction








The direction of motor rotation depends on mounting position. This setting is used to insure the door is closing and opening according to the input commands.

- 1) If operator is in RUN mode, press CAL/RUN  to enter calibration mode.
- 2) Press SET/CLEAR  to begin the calibration procedure and advance to the next screen. **Figure 3.**
- 3) Briefly press the CLOSE  key. (Pressing the Scroll key at this point will exit this control function.)
  - The display will read " DID DOOR CLOSE? " **Figure 4.**
- 4) Press SCROLL  key (up or down) to toggle between YES and NO. **Figure 5.**
  - If YES is selected, no change to operator calibration is made. If NO is selected — the POD will change the operator's down direction.
- 5) Press the SET/CLEAR  key.
- 6) Press CAL/RUN  to return to run mode.










## Setting Travel Limits

### UP and/or DOWN

- 1) If operator is in RUN mode, press CAL/RUN  to enter calibration mode.
- 2) Press SCROLL  until display reads "UP LIMIT>CLR " or "DOWN LIMIT>CLR " **Figure 6.**
- 3) Jog the door using the OPEN  or CLOSE  key until you reach the desired height.
- 4) Press SET/CLEAR  key to switch display to "UP LIMIT>SET " or "DOWN LIMIT>SET ." **Figure 7.**
- 5) Press a SCROLL  key to shift to a new function and lock in the limit setting.
- 6) Press CAL/RUN  to return to run mode.

## Resetting Travel Limits

### UP and/or DOWN

- 1) If operator is in RUN mode, press CAL/RUN  to enter calibration mode.
- 2) Press SCROLL  until display reads "UP LIMIT>SET " or "DOWN LIMIT>SET." **Figure 7.**
- 3) Press SET/CLEAR  to switch display to "UP LIMIT>CLR" or "DOWN LIMIT>CLR"
- 4) Jog the door using the OPEN  or CLOSE  key until you reach the desired height.
- 5) Press SET/CLEAR  to switch display to "UP LIMIT>SET" or "DOWN LIMIT>SET"
- 6) Press CAL/RUN  to return to run mode.

**NOTE:** The recommended setpoint for the DOWN Travel Limit is normally at approximately 2 inches off the floor. This final distance will be covered by the Limit Overrun Function to establish a more accurate seal.

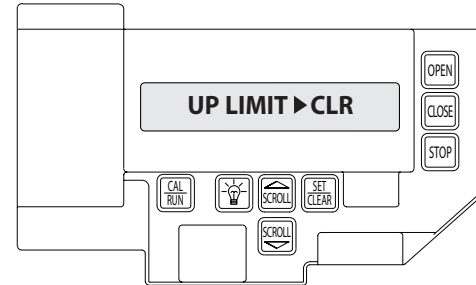


Figure 6

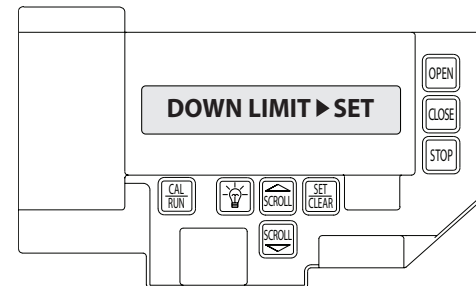


Figure 7

## Setting Limit Overrun

**⚠ WARNING:** The Limit Overrun will override external reversing devices, including photocells and sensing edges or reversing edges. Therefore, any externally connected devices will be disabled during that portion of the door travel controlled by the Limit Overrun function.  
The Down Limit Overrun function should be used to close the door no more than the final 2".

**⚠ AVERTISSEMENT:** La fonction de dépassement de limite annulera les dispositifs de renversement externes, y compris les cellules photoélectriques et des systèmes de détection ou d'inversion aux bords. En conséquence, tous les dispositifs externes connectés seront désactivés pendant la partie de la course de la porte qui est contrôlée par la fonction de dépassement de limite.  
La fonction de dépassement de limite inférieure doit être utilisée pour fermer la porte uniquement aux derniers 5 cm.

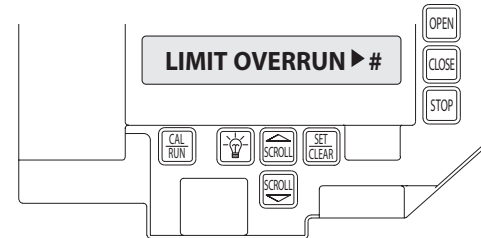
- A) The Limit Overrun setting is a matter of trial and error. The goal is to adjust the Limit Overrun until an appropriate seal is obtained between the bottom edge of the door and the floor.
- B) The Limit Overrun setting can be varied between 0 and 9. 0 - disables the Limit Overrun so that the door stops at the down limit switch setting. 9 - causes the greatest amount of door travel beyond the limit switch setting. Door should close gently with light tension on door cables, or minimal stacking on rolling steel slats.
- 1) Press CAL-RUN to enter calibration mode
  - 2) Press scroll (DN) until the display reads "LIMIT OVERRUN>(0-9)." **Fig. 8.**

- 3) Press SET/CLEAR until the display reads the desired value.
- 4) Press the OPEN key to open the door a few feet, then release
- 5) Press the CLOSE key to close the door and hold until the operator stops.
- 6) Check the door seal and repeat steps 3-5 until the appropriate seal is obtained between the door and the floor.

**⚠ CAUTION:** If proper seal cannot be obtained at a setting of 9, Reset the Limit Overrun back to 0 and reset the Down Limit position as described on 6.3. Then adjust the Limit Overrun as instructed above.

**⚠ ATTENTION:** Si une adhésion appropriée ne peut être obtenue à un réglage de 9, réinitialiser le dépassement de limite à 0 puis la position de déplacement de la limite inférieure selon les instructions de la page 6.3. Régler ensuite le dépassement de limite tel qu'indiqué ci-dessus.








- 7) Press CAL-RUN to return to Run mode.










**Figure 8**

## Setting Open and Close Modes (Constant vs Momentary Contact)

### OPEN

- 1) If operator is in RUN mode, press CAL/RUN  to enter calibration mode.
- 2) Press SCROLL  until display reads "OPEN MODE>MOM" or "OPEN MODE>C-STP." **Figure 9.**
  - MOM=momentary contact, meaning you **press and release** the OPEN  or CLOSE  key and **the door will continue to move** until it reaches its travel limit. (See NOTE)
  - C-STP=constant contact-stop, meaning **if you release the key** prior to the door reaching its travel limit, **the door will stop.**
- 3) Press SET/CLEAR  key to toggle between "OPEN MODE>C-STP" or "OPEN MODE>MOM" on the display.
- 4) Press a SCROLL  key to shift to a new function and lock in the setting.
- 5) Press CAL/RUN  to return to run mode.

### CLOSE

- 1) If operator is in RUN mode, press CAL/RUN  to enter calibration mode.
- 2) Press SCROLL  until display reads "CLOSE MODE>MOM," "CLOSE MODE>C-STP" or "CLOSE MODE>C-REV." **Figure 9.**
  - MOM=momentary contact, meaning you **press and release** the OPEN  or CLOSE  key and **the door will continue to move** until it reaches its travel limit. (See NOTE)
  - C-STP=constant contact-stop, meaning **if you release the key** prior to the door reaching its travel limit, **the door will stop.**
  - C-REV=constant contact-reverse, meaning **if you release the key** prior to the door reaching its travel limit, **the door will reverse direction.** (See NOTE)
- 3) Press SET/CLEAR  key to toggle between "CLOSE MODE>C-STP" or "CLOSE MODE>C-REV" or "CLOSE MODE>MOM" on the display.
- 4) Press a SCROLL  key to shift to a new function and lock in the setting.
- 5) Press CAL/RUN  to return to run mode.

**NOTE:** Momentary contact (**MOM**) or Constant Reverse (**C-REV**) may not be used unless both the OPEN and CLOSE Limits have been set.

In situations where an external reversing device is either not installed or not operating properly, Constant Contact (**C-STP**) **MUST BE USED.**

**⚠ WARNING:** Before momentary contact control can be used on the CLOSE button, a monitored external reversing device such as a photocell system or sensing edge switch must be used. See pages 5.7-5.9 for installation of entrapment protection devices.

**⚠ AVERTISSEMENT:** Avant d'utiliser la commande à contact momentané sur le bouton FERMETURE, un dispositif d'inversion externe surveillée tel qu'un système de cellule photoélectrique ou un commutateur de détection de bord doit être utilisé. Voir l'installation des dispositifs de protection contre le coincement en pages 5.7-5.9.

**NOTE:** During adjustment of a Travel Limit, the Open and Close Modes will automatically fail-safe to Constant Contact until the Limit has been set or reset. At that time the Open and Close Modes will revert to their previous setting.

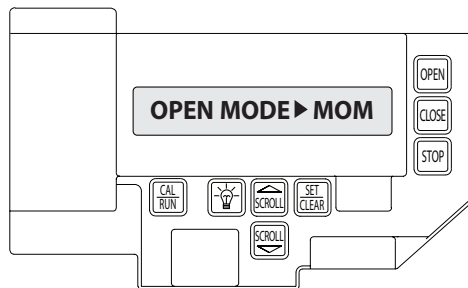





Figure 9




## Setting Mid-Stop Limit

The CDX® Operator includes a programmable Mid-Stop. This feature allows the operator to stop at a user selectable point when opening. It is used when operating very tall doors that only open to their full height occasionally. The Mid-Stop does not effect the operator when closing. To operate door to full open position from mid-stop, press open button again.





**NOTE:** Setting of the MID-STOP should only be performed AFTER Travel Limit and Max Run Timer settings have been made.

- 1) Press CAL/RUN  to enter calibration mode.
- 2) Press the CLOSE  to close the door to the down limit.
- 3) Press SCROLL  until display reads "MID-STOP > CLR" **Figure 10.**

**NOTE:** If the display reads MID-STOP > SET at this point, first clear the MID-STOP as described below then repeat steps 1-3 and continue.

- 4) Press the OPEN  to open the door to desired mid-stop height.
- 5) Press SET/CLEAR  until the display reads "MID-STOP > SET"
- 6) Press CAL/RUN  to return to run mode.

To CLEAR the Limit

- 7) Press CAL/RUN  to enter calibration mode.
- 8) Press SCROLL  until display reads "MID-STOP > SET"
- 9) Press SET/CLEAR  until the display reads "MID-STOP > CLR"
- 10) Press CAL/RUN  to return to run mode.

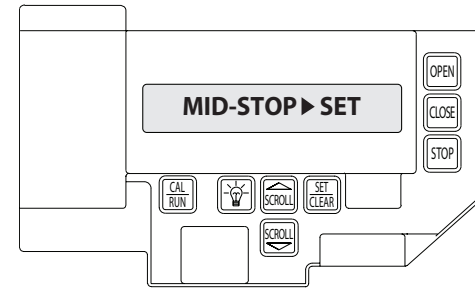






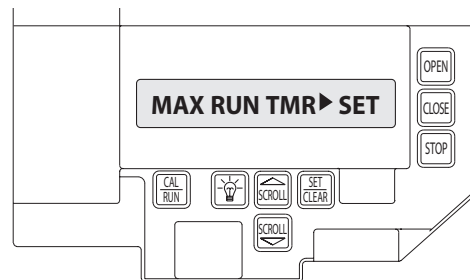
Figure 10

**Resetting the MRT** *(The Max Run Timer is set automatically once the unit is cycled between Limits, 2 full cycles. The Max Run Timer prevents the unit from running continuously in the event of a problem. The MRT's are set to the time required to run from one limit to the other, plus 5 seconds (nominal). When the MRT is exceeded, the operator stops and will not respond to any command until it is reset by pressing one of the calibration keys or by cycling power to the unit.*

**TO RESET**

- 1) Press CAL/RUN  to enter calibration mode.
- 2) Press SCROLL  (up or down) until display reads "MAX RUN TMR > SET." **Fig. 11.**
- 3) Press SET/CLEAR  until display reads "MAX RUN TMR > CLR."
- 4) Press CAL/RUN  to return to RUN mode.
- 5) Cycle the door between limits, 2 full cycles.

**NOTE: The Max Run Timer must be reset each and every time the Travel Limits are adjusted.**








**Figure 11**

**⚠ CAUTION:** The MID-STOP feature must be turned off in order to properly set the Max Run Timer.

**⚠ ATTENTION:** La fonction MID-STOP doit être désactivée afin de régler correctement la minuterie de course maximum.

## Monitored Reversing Devices

### ODC Safe-T-Beams® (OPTIONAL)

- 1) If operator is in RUN mode, press CAL/RUN  to enter calibration mode.
- 2) Press SCROLL  (up or down) until display reads "ODC STB>ON" or "ODC STB>OFF" **Figure 12**
- 3) Press SET/CLEAR  key to toggle between ON and OFF.
- 4) Press SCROLL  (up or down) to shift to a new function and lock setting.
- 5) Press CAL/RUN  to return to run mode.

**⚠ WARNING:** Photocell systems provide entrapment protection when mounted near the doorway in such a way that the lower portion of an individual's leg will break the photocell beam during normal walking through the doorway.

**⚠ AVERTISSEMENT:** Les systèmes de cellules photoélectriques fournissent une protection contre le coincement s'ils sont installés à proximité de la porte de manière à ce que la partie inférieure de la jambe d'un individu puisse rompre le faisceau de la cellule photoélectrique lors de passages normaux par la porte.

**NOTE:** Installation of Series II Safe-T-Beam® or Residential Safe-T-Beam® Monitored Photocells DOES NOT make the CDX® unit legal for residential use. The Overhead Door Corporation strictly prohibits any installation of a CDX® unit in any residentially zoned construction.

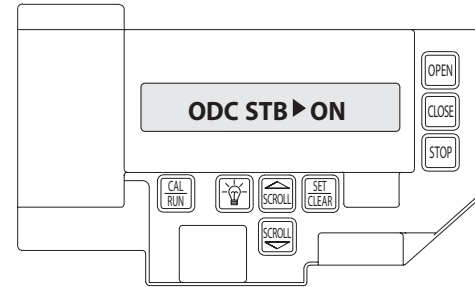





Figure 12

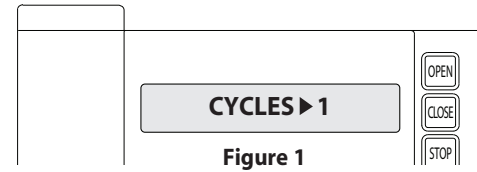
## Current UL Approved Monitored Reversing Devices

- 1) MillerEdge ME and MT series monitored edge sensors used in combination with Timer-Close Module P/N OPABTCX.S.
- 2) MillerEdge ME and MT series monitored edge sensors used in combination with MillerEdge Interface Module OPAKMEIGX.S. (Direct connect through STB inputs).
- 3) MillerEdge Wireless monitored edge sensor OPAKMMWE.S.
- 4) Residential Safe-T-Beam® Monitored Photocells - P/N 37221R (OSTB-BX) and 38176R.S (includes extension brackets)
- 5) Series II Commercial Safe-T-Beam® Monitored Photocells - P/N OPAKPE.S and OPAKPEN4GX.S (NEMA 4).
- 6) Monitored Retro-Reflective Photoeye - P/N OPRAKRPEN4X.S




## Section 7: Special Operator Features (No user input)

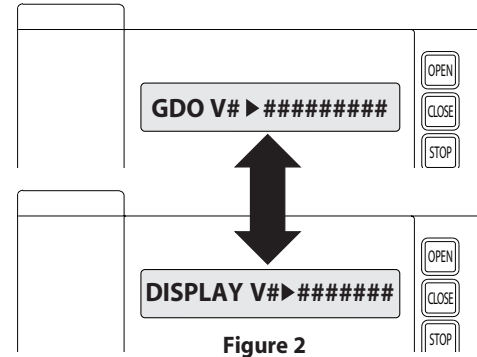
### Operator Cycle Count

- 1) Press CAL/RUN  to enter calibration mode.
- 2) Press SCROLL  until display reads "CYCLES>1,2,3 etc. where the number is the number of open/close cycles the operator has performed. **Figure 1**.
- 3) Press CAL/RUN  to return to run mode.



### GDO and Display Firmware

- 1) Press CAL/RUN  to enter calibration mode.
- 2) Press SCROLL  until display reads "GDO V# > #####." **Figure 2**. This display will cycle between the version number of the current GDO firmware and the current Display Firmware.
- 3) Press CAL/RUN  to return to run mode.









## Operator Type Fig. 3

CDX® operator circuit boards are available for use in jackshaft or trolley configurations. The same control board is used for either configuration, however the control board must be set for the appropriate GDO configuration. A board set for trolley mode will not work in a jackshaft operator and vice-versa.

**NOTE:** The GDO type is factory set. The installer should not have to set this feature. However, if the GDO type is inadvertently changed, or if a board needs to be replaced in the field, follow these instructions to set GDO type.

- 1) Press CAL/RUN  to enter calibration mode.
- 2) Press SCROLL  until display reads "GDO TYPE > ."  
This will display the current GDO type.
- 3) Press SET/CLEAR  until display indicates correct GDO type (J-SHAFT).
- 4) Press CAL/RUN  to return to run mode.

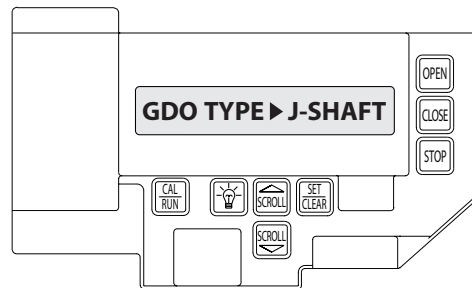


Figure 3

## Optional Hand Crank

For taller doors, it may be desirable to be able to raise and lower door during power interruptions, using a mechanical assist, rather than manually pushing or pulling door open and closed. A Hand Crank option is available that can be installed in field. Operator output shaft extends through CDX® opposite output sprockets to accept hand crank gearing.

- 1) Remove electrical power to operator.
- 2) Install TOP crank gear bracket above output shaft on operator side frame. **FIG. 5 & 6.** Use two(2) 1/4"-20 x 1/2" self-tapping screws and two(2) mounting holes provided.
- 3) Slide bevel gear onto output shaft with teeth facing away from CDX® frame and insert key into keyway. Retain gear using 5/8" external retaining ring. **FIG. 7.**
- 4) Put top end of shaft of Crank Gear Shaft Subassembly through hole in top crank bracket and fasten bottom crank bracket to CDX® frame with two(2) 1/4"-20 x 1/2" self-tapping screws. **FIG. 8.**

Figure 4

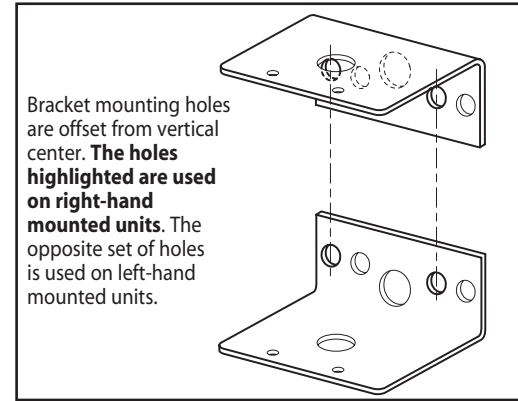


Figure 5

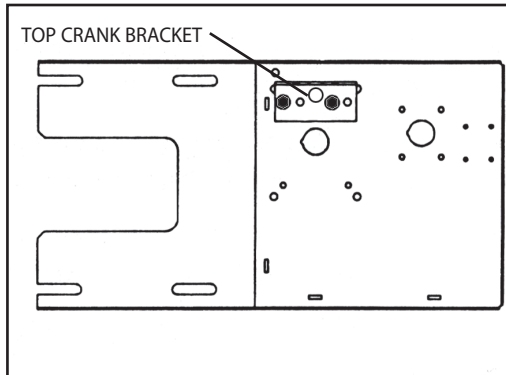


Figure 6

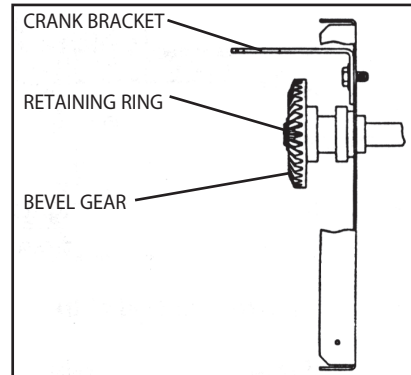
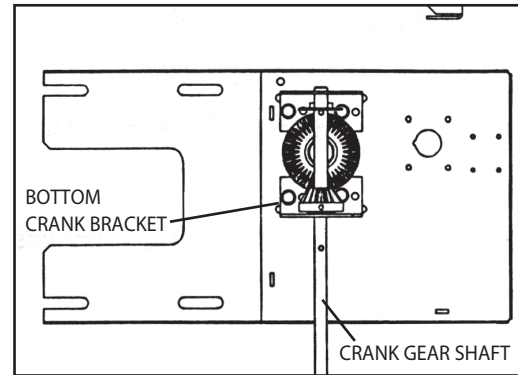


Figure 7

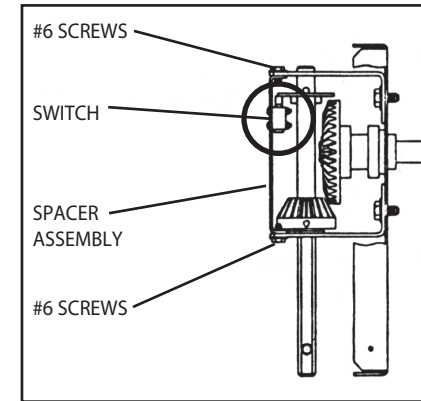


## Optional Hand Crank (continued)

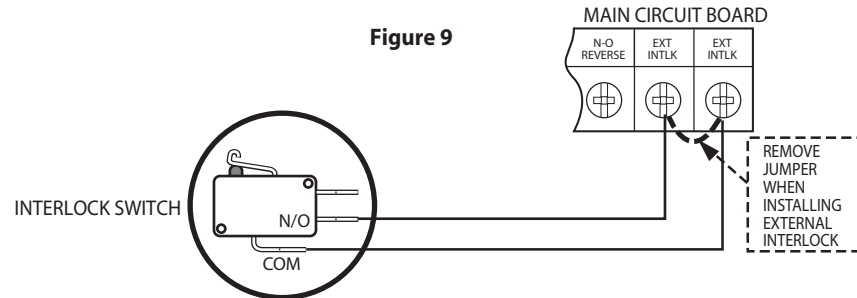
- 5) Place spacer assembly between top and bottom crank brackets with INTERLOCK SWITCH TOWARD TOP and SWITCH ACTUATOR LEVER BELOW WASHER. **FIG. 8.**
    - Secure using four(4) #6 self-tapping screws.
  - 6) Connect interlock switch wire harness to common and normally open contact on switch.
    - Insert plastic bushing into 1/2" hole on frame.
  - 7) Route harness through bushing and then through bushing on electrical support panel.
    - Attach wires to Interlock Terminals\* on main circuit board. **FIG.9.**
  - 8) Insert four(4) tabs on cover into slots next to crank brackets and secure cover to spacer assembly with four(4) #6 self-tapping screws.
- 9) TEST CRANK OPERATION.**

- Engage hand crank onto crank shaft and push up to engage bevel gears.
- Pull manual release rope and crank door to desired position. *Interlock switch prevents motor operation during hand cranking if power should suddenly be restored.*
- Lower Hand crank to disengage bevel gears.
- Release Manual Release Rope.
- Restore power.

**Figure 8**



**Figure 9**



# Section 8: Troubleshooting

## Display Operation in Run Mode

CDX® operators display their status on the integrated display. Each time the operator runs, stops, reverses or refuses to run, the display will indicate why the action did, or did not, take place.

Once an error code has been generated, the CDX® operator will continue to display the error code while the operator is not running. This error code can be cleared by pressing the STOP button or STOP key on the keypad. The error code will automatically clear when the operator stops at the down limit. Error codes will continue to be stored in the CDX® operator's Error Code Memory after they have been cleared from the display in the Run Mode.

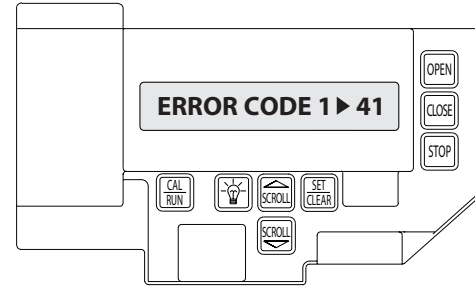


Figure 1

## Error Codes

To aid in troubleshooting problems, CDX® operators include an error code memory that stores the last 10 error events. These codes are stored with or without power. The last error code detected is also displayed on the LCD until the stop button or key is pressed or the operator stops at the down limit.

The error code memory stores the last 10 error codes in sequence. Once 10 codes are stored, the oldest code is erased to make room for the newest code. These codes are displayed in calibration mode. The display will flash the number of the error code and the 2-digit error code followed by a description of the error code. **Fig. 1 & 2.**

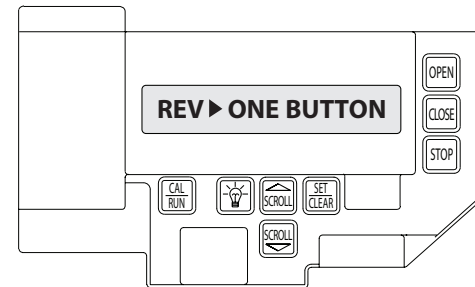






Figure 2

## Error Codes (continued)

### To view the error code memory:

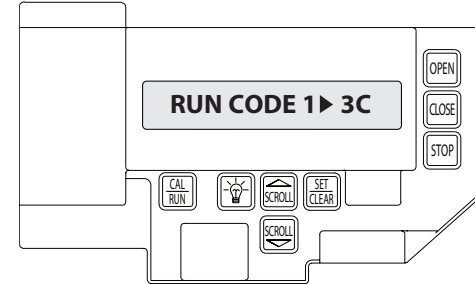
- 1) Press CAL/RUN  to enter calibration mode.
- 2) Press SCROLL  until display reads "ERROR CODE 1 >".
  - The display will begin flashing the error code number and 2-digit error code followed by its description.
  - Reminder: Error code number 1 is the latest code generated.
- 3) Press SET/CLEAR . The display will now read "ERROR CODE 2 > ." (This is the error code which was generated before error code 1.)
- 4) Repeat step 3 until all 10 error codes have been displayed or move on to step 5 when ready.
- 5) Press CAL/RUN  to return to run mode.

**NOTE:** For all error codes see Appendix C, Sections 10.6-10.7.

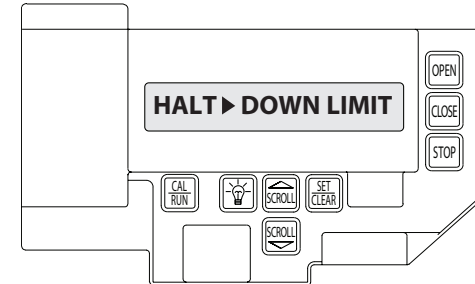
## Run Codes

CDX® operators also include a run code memory that stores the last 10 run events. These codes are stored with or without power. Each time the operator runs or stops, it generates a code that it stores in this memory (Why the operator ran or stopped). Used together with the error code memory, it becomes a powerful troubleshooting aid.

The run code memory stores the last 10 codes in sequence. Once 10 codes are stored, the oldest code is erased to make room for the newest code. These codes are displayed in calibration mode. The display will flash the number of the run code and the 2-digit run code followed by a description of the run code. **Fig. 3 & 4.**







**Figure 3**



**Figure 4**

## Run Codes (continued)

### To view the run code memory:

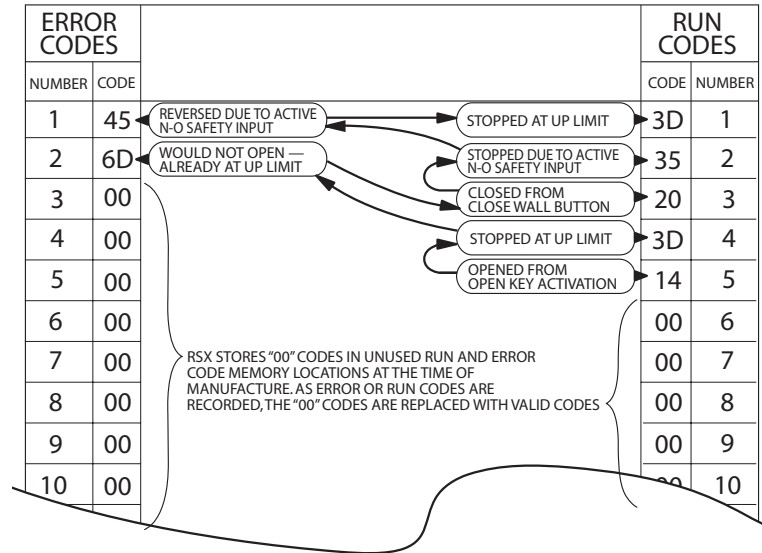
- 1) Press CAL/RUN  to enter calibration mode.
- 2) Press SCROLL  until display reads "RUN CODE 1 > ."
  - The display will begin flashing the run code number and code followed by its description.
  - Remember: run code number 1 is the latest code generated.
- 3) Press SET/CLEAR . The display will now read "RUN CODE 2 > ." (This is the run code which was generated before run code 1.)
- 4) Repeat step 3 until all 10 run codes have been displayed or move on to step 5 when ready.
- 5) Press CAL/RUN  to return to run mode.

**NOTE:** For all run codes see Appendix C, Section 10.5.

### TROUBLESHOOTING EXAMPLE USING RUN AND ERROR CODE MEMORIES. Fig. 5

1. In Calibration Mode, display and write down each Run Code and Error Code stored in memory.
2. List as shown in Fig. 5.
3. Refer to Appendix C to interpret the codes.

In this example, the operator was opened using the OPEN key on the keypad and stopped at the up limit. The OPEN wall button was then activated, causing the "6D" code to be generated since the operator could not open when it is already at the up limit. The CLOSE wall button was then activated, causing the operator to close. While closing, the Normally-Open (N-O) Safety Input was activated, causing the operator to stop and then reverse, stopping at the up limit.



**Figure 5**

## LED Indicators Fig. 6

CDX® operators include a self-diagnostic circuit board using troubleshooting LED indicators to signal the technician of a problem.

TROUBLESHOOTING LED'S				
HOIST INTERLOCK	EXTERNAL INTERLOCK	+ 24 VOLTS DC	STB ENABLE	INDICATION
			OFF	STB DISABLED
			ON	STB ENABLED
ON	ON	ON		NORMAL OPERATING CONDITION
OFF	ON	ON		HOIST INTERLOCK SWITCH OPEN: 1) HOIST RELEASE NEEDS RESET. 2) HOIST INTERLOCK CONNECTOR NOT PLUGGED IN. 3) HOIST INTERLOCK DEFECTIVE.
OFF	OFF	ON		EXTERNAL INTERLOCK OPEN
OFF	OFF	OFF		POWER SUPPLY PROBLEM: 1) CHECK AC POWER SUPPLY. 2) CHECK MAIN POWER FUSE. 3) CHECK SECONDARY FUSE (2A).

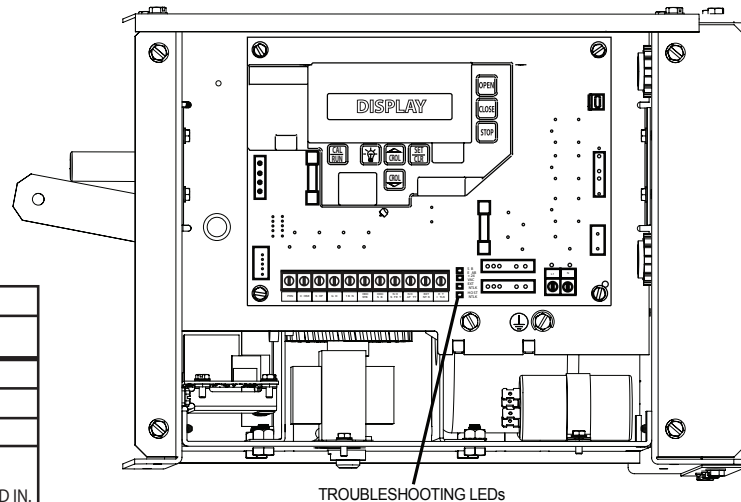


Figure 6

## Safe-T-Beam® Monitored Photocell Self-diagnostic Troubleshooting Chart

SOURCE (RED LED)	SENSOR (GREEN LED)	INDICATED CONDITION	REQUIRED ACTION
● ON	● ON	NORMAL OPERATION	NONE REQUIRED
○ OFF	○ OFF	1. POWER HEAD NOT POWERED 2. WIRING FROM POWER HEAD BAD	1. CHECK BREAKERS, FUSES, PLUGS 2. CHECK WIRING FOR OBVIOUS SHORTS
○ OFF	● ON	1. WIRING TO SOURCE MISSING OR BAD 2. POWER HAS BEEN INTERRUPTED	1. CHECK WIRING 2. REMOVE POWER AND REAPPLY
2 BLINKS, PAUSE (REPEAT)	● ON	1. BEAM NOT ALIGNED 2. BEAM OBSTRUCTED 3. SENSOR DEFECTIVE	1. CHECK ALIGNMENT 2. CHECK FOR OBSTRUCTION 3. CALL CUSTOMER SERVICE
2 BLINKS, PAUSE (REPEAT)	○ OFF	1. WIRE TO SENSOR MISSING OR BAD 2. SENSOR DEFECTIVE	1. CHECK WIRING 2. CALL CUSTOMER SERVICE
3 BLINKS, PAUSE (REPEAT)	● ON	1. SENSOR RECEIVING INTERFERENCE	1. ATTEMPT TO DETERMINE SOURCE OF INTERFERENCE 2. CALL CUSTOMER SERVICE
4 BLINKS, PAUSE (REPEAT)	● ON	1. SOURCE NOT SENDING PULSES 2. SOURCE DEFECTIVE	1. CALL CUSTOMER SERVICE 2. CALL CUSTOMER SERVICE

**⚠ WARNING:** ACTUATING THE OPERATOR BY USING CONSTANT CONTACT ON THE CLOSE BUTTON WILL OVERRIDE NON-FUNCTIONING EXTERNAL REVERSING DEVICES, INCLUDING PHOTOCELLS.

**⚠ AVERTISSEMENT:** L'ACTIVATION DE L'OPERATEUR EN UTILISANT UN CONTACT CONSTANT SUR LE BOUTON FERMER ANNULERA LES DISPOSITIFS D'INVERSIONS EXTERNES, Y COMPRIS LES CELLULES PHOTOELECTRIQUES.

**⚠ WARNING:** Overhead Door Corporation recommends that line voltage wiring be performed by qualified electrician. See Section 5 for additional wiring instructions.

**⚠ AVERTISSEMENT:** Overhead Door Corporation recommande que le câblage au secteur soit effectué par un électricien qualifié. Voir la section 5 pour des instructions supplémentaires sur le câblage.



## Section 9: Service and Maintenance

### Maintenance Schedule

The following table provides a schedule of recommended Service and Maintenance items to be completed by a trained service representative.

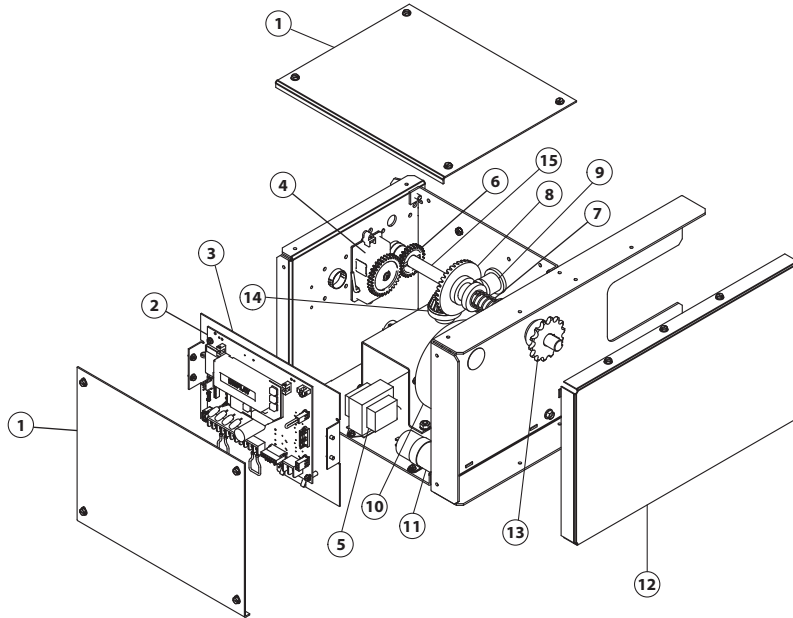
**⚠ CAUTION:** Failure to perform the recommended Service & Maintenance may result in premature failure of the operator.

**⚠ ATTENTION:** Si les instructions de service et de maintenance recommandés ne sont pas suivies, l'opérateur pourrait tomber en panne prématurément.

SERVICE ITEM	SERVICE INTERVAL (FREQUENCY)			
	MONTHLY	EVERY 6 MO. OR 5,000 CYCLES	EVERY 12 MO. OR 10,000 CYCLES	EVERY 36 MO. OR 30,000 CYCLE
MANUAL OPERATION OF DOOR		●		
CHECK DRIVE CHAINS AND LUBRICATE			●	
PHOTOCELL/ SENSING EDGE OPERATION	●			
CHECK FOR LOOSE OR MISSING HARDWARE			●	
CHECK LIMIT POSITION				●
GEAR TRAIN WEAR				●

# Section 10: Appendix A

## Operator Parts Breakdown (Right Hand Unit Shown)

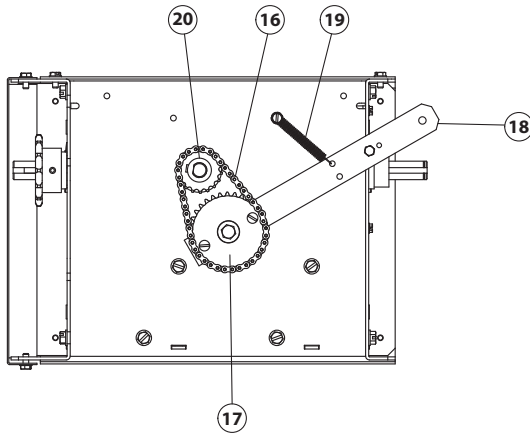


Item	Part Number	Description	Qty
<b>OPER ASSY, COUNTER DOOR, CDX</b>			
1	108802.0002	COVER, POWERHEAD, BLACK	1
2	111883.0001	CIRCUIT BOARD ASSY	1
3	111629.0001	BRKT, SUPPORT, PCB	1
4	111421.0003	LIMIT MODULE	1
5	110846.0001	XFMR, 120V	1
6	111885.0001	GEAR, LIMIT, 26T	1
7	108122.0001	SPRING, DENTIL	1
8	111531.0001	GEAR, BEVEL, 36T	1
9	108855.0001	SHAFT ASSY, DENTIL	1
10	111710.0001	MOTOR, 115V	1
11	107871.0001	CAPACITOR, MOTOR START	1
12	111936.0001	CHAIN GUARD	1
13	108819.0001	SPRKT, #41, 14T	1
14	077829.0001	GEAR, PINION	1
15	111627.0001	SHAFT, OUTPUT, RH	1
	111627.0002	SHAFT, OUTPUT, LH	1
NS	108609.0001	GEAR, HELICAL	1
NS	108608.0001	GEAR, WORM	1

\*NS - NOT SHOWN

# Section 10: Appendix A

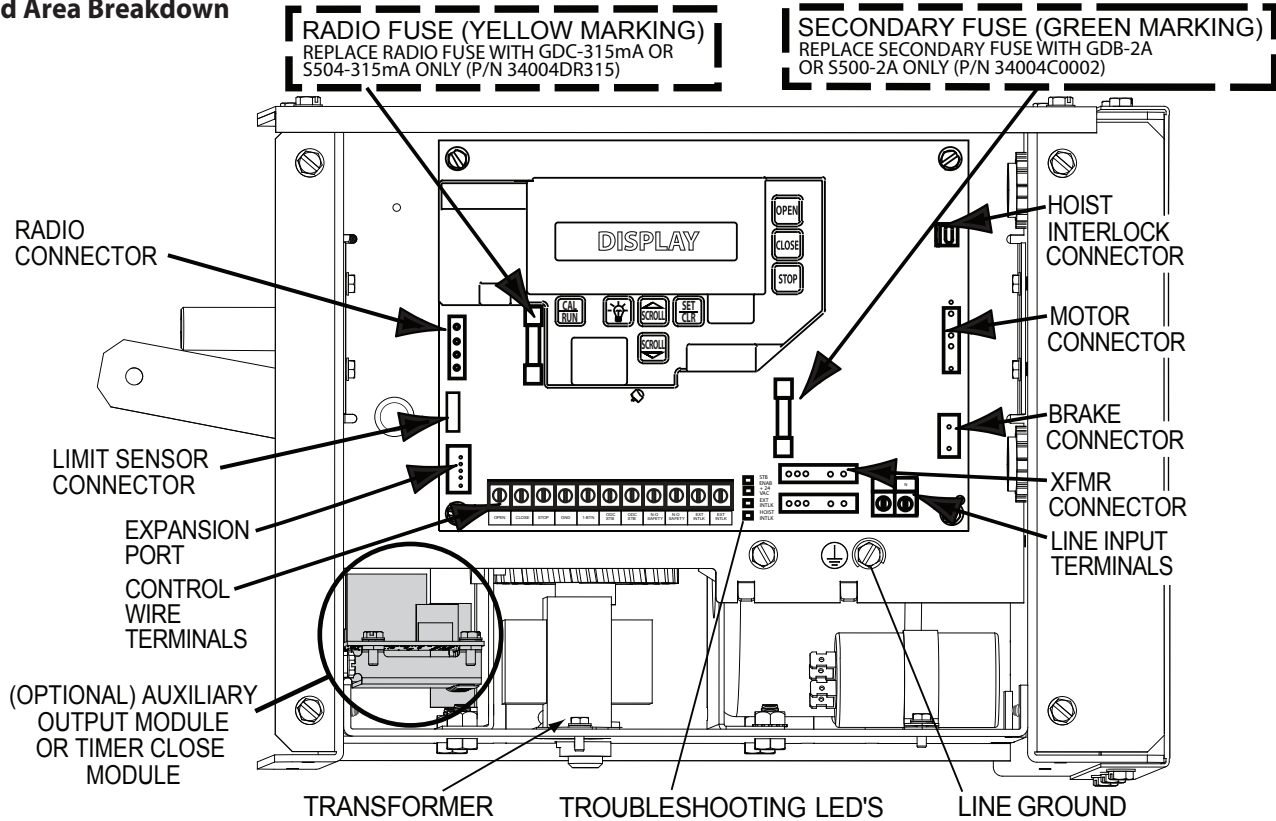
## Release Parts Breakdown (Right Hand Unit Shown)



Item	Part Number	Description	Qty
		<b>RELEASE PARTS, CDX</b>	
16	086565.1004	CHAIN, #25 X 44P, LOOP	1
17	108806.0001	SPRKT, #25, 32T	1
18	108822.0001	LEVER, RELEASE	1
19	108123.0001	SPRING	1
20	086563.0005	SPRKT, #25, 18T	1

# Section 10: Appendix A

## Control Board Area Breakdown



## Section 10: Appendix B

### Screw Terminal Assignments

INPUT	FUNCTION	CONNECTION TYPE
<b>11-POSITION TERMINAL BLOCK</b> INSIDE ELECTRIC BOX	OPEN	Causes door to open if not at Up Limit. Causes a closing door to reverse.
	CLOSE	Causes door to close if not at Down Limit.
	STOP	Causes a moving door to stop. Prevents the operator from running.
	GND	Common ground connection for Open, Close, Stop & 1-Btn Inputs.
	1-BTN	Causes door to open if not at Up Limit or Mid-Stop Limit. Causes door to close if at Up Limit or Mid-Stop Limit. Causes door to stop if opening. Causes a closing door to reverse.
	ODC STB	Reverses a closing door if photocell beam is blocked. NOTE: STB's must be enabled in Calibration Mode.
	ODC STB	Reverses a closing door if photocell beam is blocked. NOTE: STB's must be enabled in Calibration Mode.
	N-O SAFETY	Causes a closing door to reverse. NOTE: Will not open a stopped door.
	N-O SAFETY	Causes a closing door to reverse. NOTE: Will not open a stopped door.
	EXT INTLK	Causes a moving door to stop. Prevents the operator from running when contact is open. Operates even if microcontroller is non-functional.
	EXT INTLK	Causes a moving door to stop. Prevents the operator from running when contact is open. Operates even if microcontroller is non-functional.
	<b>2-POSITION TERMINAL BLOCK</b> (INSIDE ELECTRIC BOX)	L1 / L1
N / L2		Power to operator
PWR		Power for radio & other accessories. +20 to +40VDC, fused at 315mA (F1).
<b>RADIO AND ACCESSORIES PIGTAIL</b>	RAD (Radio Input Control)	Causes door to open if not at Up Limit or Mid-Stop Limit. Causes door to close if at Up Limit or Mid-Stop Limit. Causes a closing door to reverse.
	GND	Common ground connection for PWR and RAD terminals.
	EXPANSION PORT	Connects accessory modules to RSX™ operator.
<b>PLUG CONNECTIONS</b> INSIDE ELECTRIC BOX	TRANSFORMER	Connects main transformer to control board.
	BRAKE	Connects brake solenoid to control board.
	MOTOR	Connects motor and capacitor to control board.
	HOIST INTLK	Causes moving door to stop. Prevents the operator from running. Operates even if microcontroller is non-functional.
	LIMIT SENSOR	Causes door to stop at top and bottom of normal travel.

# Section 10: Appendix C

## Run Code Displays

Condition Code	DISPLAY	Condition Code Description
<b>0C</b>	<b>IDLE &gt; DOWN LIMIT</b>	<b>STANDING BY AT DOWN LIMIT (NOTE: THIS MESSAGE IS DISPLAYED IF BOTH LIMITS ARE ACTIVE)</b>
0D	IDLE > UP LIMIT	STANDING BY AT UP LIMIT
0E	IDLE > MID STOP	STANDING BY AT MID-STOP LIMIT
0F	IDLE > NO LIMIT	STANDING BY BETWEEN LIMITS
<b>10</b>	<b>OPENING &gt; OPEN BTN</b>	<b>OPENING FROM OPEN BUTTON</b>
11	OPENING > ONE BTN	OPENING FROM 1 BUTTON
12	OPENING > RADIO	OPENING FROM RADIO
13	OPENING > AUX OPEN	OPENING FROM AUXILIARY OPEN INPUT
14	OPENING > OPEN KEY	OPENING FROM KEYPAD OPEN KEY
<b>20</b>	<b>CLOSING &gt; CLOSE PB</b>	<b>CLOSING FROM CLOSE BUTTON</b>
21	CLOSING > ONE BTN	CLOSING FROM 1 BUTTON
22	CLOSING > RADIO	CLOSING FROM RADIO
24	CLOSING > CLOSE KP	CLOSING FROM KEYPAD CLOSE KEY
<b>2A</b>	<b>CLOSING &gt; TCM CLS</b>	<b>CLOSING FROM TIMER CLOSE MODULE</b>
2B	CLOSING > FDM CLS	CLOSING FROM FORE DOOR MODULE
<b>30</b>	<b>HALT &gt; WALL BUTTON</b>	<b>GDO STOPPED BECAUSE STOP OR OPEN BUTTON WAS ACTIVATED, POSSIBLY STARTING A REVERSAL</b>
31	HALT > ONE BUTTON	GDO STOPPED BECAUSE 1 BUTTON WAS ACTIVATED, POSSIBLY STARTING A REVERSAL
32	HALT > RADIO	GDO STOPPED BECAUSE RADIO INPUT WAS ACTIVATED, STARTING A REVERSAL
33	HALT > AUX. OPEN	GDO STOPPED BECAUSE AUXILIARY OPEN INPUT WAS ACTIVATED, STARTING A REVERSAL
34	HALT > KEYPAD KEY	GDO STOPPED BECAUSE KEYPAD STOP OR OPEN KEY WAS ACTIVATED, POSSIBLY STARTING A REVERSAL
35	HALT > N-O SAFETY	GDO STOPPED BECAUSE N-O REVERSING INPUT WAS ACTIVATED, STARTING A REVERSAL
36	HALT > ODC STB	GDO STOPPED BECAUSE ODC STB WAS BLOCKED, STARTING A REVERSAL
37	HALT > N-C SAFETY	GDO STOPPED BECAUSE N-C REVERSING INPUT WAS ACTIVATED, STARTING A REVERSAL
38	HALT > MON. EDGE	GDO STOPPED BECAUSE MONITORED EDGE SENSOR INPUT WAS ACTIVATED, STARTING A REVERSAL
39	HALT > DOOR FORCE	GDO STOPPED BECAUSE THE FORCE REQUIRED TO OPERATE THE DOOR WAS TOO HIGH, POSSIBLY STARTING A REVERSAL
<b>3A</b>	<b>HALT &gt; LOSS OF C/C</b>	<b>GDO STOPPED BECAUSE CONSTANT CONTACT ON CONTROL REMOVED BEFORE REACHING A LIMIT, POSSIBLY STARTING A REVERSAL</b>
3B	HALT > SHUTDOWN	GDO STOPPED BECAUSE THE GDO DETECTED A FAULT SUCH AS AN OPEN INTERLOCK, OVERHEATED MOTOR, ETC.
3C	HALT > DOWN LIMIT	GDO STOPPED BECAUSE IT REACHED THE DOWN LIMIT
3D	HALT > UP LIMIT	GDO STOPPED BECAUSE IT REACHED THE UP LIMIT
3E	HALT > MID STOP	GDO STOPPED BECAUSE IT REACHED THE MID-STOP LIMIT
3F	HALT > MODULE FAIL	GDO STOPPED BECAUSE AN EXPANSION MODULE WAS NOT WORKING PROPERLY
<b>40</b>	<b>REV &gt; OPEN BUTTON</b>	<b>GDO REVERSED BECAUSE THE OPEN BUTTON WAS ACTIVATED</b>
41	REV > ONE BUTTON	GDO REVERSED BECAUSE THE 1 BUTTON WAS ACTIVATED
42	REV > RADIO	GDO REVERSED BECAUSE THE RADIO INPUT WAS ACTIVATED
43	REV > AUX OPEN	GDO REVERSED BECAUSE THE AUXILIARY OPEN INPUT WAS ACTIVATED
44	REV > OPEN KEY	GDO REVERSED BECAUSE THE KEYPAD OPEN KEY WAS ACTIVATED
45	REV > N-O SAFETY	GDO REVERSED BECAUSE THE N-O REVERSING INPUT WAS ACTIVATED

# Section 10: Appendix C

## Error Code Displays

Condition Code	DISPLAY	Condition Code Description
46	REV > ODC STB	GDO REVERSED BECAUSE THE ODC STB WAS BLOCKED
47	REV > N-C SAFETY	GDO REVERSED BECAUSE THE N-C REVERSING INPUT WAS ACTIVATED
48	REV > MON. EDGE	GDO REVERSED BECAUSE THE MONITORED EDGE SENSOR WAS ACTIVATED
49	REV > DOOR FORCE	GDO REVERSED BECAUSE THE FORCE REQUIRED TO CLOSE THE DOOR WAS TOO HIGH
<b>4A</b>	<b>REV &gt; LOSS OF C/C</b>	<b>GDO REVERSED BECAUSE CONSTANT CONTACT ON THE CONTROL WAS REMOVED BEFORE REACHING THE DOWN LIMIT</b>
4B	REV > MAX RUN TMR	GDO REVERSED BECAUSE THE CLUTCH SLIPPED OR SOME OTHER FAULT OCCURRED THAT ALLOWED THE GDO TO RUN TOO LONG
4F	REV > EXP MOD FAIL	GDO REVERSED BECAUSE AN EXPANSION MODULE WAS NOT WORKING PROPERLY
<b>50</b>	<b>STOP &gt; HOT MOTOR</b>	<b>GDO STOPPED BECAUSE THE MOTOR WAS OVERHEATED</b>
51	STOP > OPEN MRT	GDO STOPPED BECAUSE THE CLUTCH SLIPPED OR SOME OTHER FAULT OCCURRED THAT ALLOWED THE GDO TO RUN OPEN TOO LONG
52	STOP > CLOSE MRT	GDO STOPPED BECAUSE THE CLUTCH SLIPPED OR SOME OTHER FAULT OCCURRED THAT ALLOWED THE GDO TO RUN DOWN TOO LONG
53	STOP > BRAKE FAULT	GDO STOPPED BECAUSE OF BRAKE ERRONEOUSLY ENGAGED
57	STOP > OPEN INTLK	GDO STOPPED BECAUSE THE HOIST INTERLOCK OR EXTERNAL INTERLOCK IS OPEN
58	STOP > WRONG GDO	GDO STOPPED BECAUSE THE BOARD IS SET FOR JACKSHAFT MODE, BUT INSTALLED IN A TROLLEY OPERATOR
59	STOP > DOOR FORCE	GDO STOPPED BECAUSE THE FORCE REQUIRED TO OPEN THE DOOR WAS TOO HIGH
<b>5A</b>	<b>STOP &gt; WRONG LIMIT</b>	<b>GDO STOPPED BECAUSE THE UP LIMIT ACTIVATED WHEN CLOSING OR THE DOWN LIMIT ACTIVATED WHEN OPENING</b>
5B	STOP > WRONG DIR	GDO STOPPED BECAUSE THE DOOR MOVED IN THE WRONG DIRECTION
5C	STALL > DOWN LIMIT	GDO STOPPED BECAUSE IT COULDN'T LEAVE THE DOWN LIMIT DUE TO A SLIPPING CLUTCH OR OTHER PROBLEM
5D	STALL > UP LIMIT	GDO STOPPED BECAUSE IT COULDN'T LEAVE THE UP LIMIT DUE TO A SLIPPING CLUTCH OR OTHER PROBLEM
5E	STALL > MID-STOP	GDO STOPPED BECAUSE IT COULDN'T LEAVE THE MID-STOP LIMIT DUE TO A SLIPPING CLUTCH OR OTHER PROBLEM
5F	STALL > NO LIMY	GDO STOPPED BECAUSE TRAVEL LIMITS HAVE NOT BEEN SET
<b>60</b>	<b>CHECK STOP BTN</b>	<b>GDO WON'T RUN BECAUSE THE STOP BUTTON IS ACTIVE</b>
61	TCM DISABLED	TIMER CLOSE WON'T WORK BECAUSE NO SAFETIES ARE ENABLED
62	NO RADIO >> C/C	RADIO INPUT WON'T WORK WITH OPEN OR CLOSE FUNCTION IN CONSTANT CONTACT MODE
63	CHECK AUX OPEN	GDO WON'T CLOSE BECAUSE AUXILIARY OPEN INPUT IS ACTIVE
64	CHECK STOP KEY	GDO WON'T RUN BECAUSE THE KEYPAD STOP KEY IS ACTIVE
65	CHECK N-O SAFETY	GDO WON'T CLOSE BECAUSE THE N-O REVERSING IS ACTIVE
66	CHECK ODC STB	GDO WON'T CLOSE BECAUSE THE ODC STB IS BLOCKED
67	CHECK N-C SAFETY	GDO WON'T CLOSE BECAUSE THE N-C REVERSING INPUT IS ACTIVE
68	CHECK MON. EDGE	GDO WON'T CLOSE BECAUSE THE MONITORED EDGE SENSOR IS ACTIVE
69	OVERHEATED MOTOR	GDO WON'T RUN BECAUSE THE MOTOR IS OVERHEATED
<b>6A</b>	<b>POWER WIRING ERROR</b>	<b>GDO WON'T RUN BECAUSE POWER SUPPLY WIRED INCORRECTLY</b>
6B	FIRE DOOR SHTDN	GDO WON'T RUN BECAUSE OF LOSS OF POWER
6C	NO RUN > DOWN LIM	GDO WON'T CLOSE BECAUSE ITS ALREADY AT THE DOWN LIMIT
6D	NO RUN > UP LIMIT	GDO WON'T OPEN BECAUSE ITS ALREADY AT THE UP LIMIT
6E	NO RUN > MID STOP	GDO WON'T RUN BECAUSE ITS AT OR ABOVE THE MID-STOP LIMIT & CAN'T RUN UP & A REVERSING INPUT IS PREVENTING IT FROM CLOSING
6F	EXP MODULE FAIL	GDO WON'T RUN BECAUSE AN EXPANSION MODULE FAILURE IS PREVENTING IT

# Section 10: Appendix C

## Error Codes Displays (continued)

Condition Code	DISPLAY	Condition Code Description
<b>70</b>	<b>BOARD FAILURE 70</b>	<b>CONTROL BOARD FAILURE 70, CONTACT FACTORY TECHNICAL SERVICE DEPT.</b>
71	BOARD FAILURE 71	CONTROL BOARD FAILURE 71, CONTACT FACTORY TECHNICAL SERVICE DEPT.
74	BOARD FAILURE 74	CONTROL BOARD FAILURE 74, CONTACT FACTORY TECHNICAL SERVICE DEPT.
75	BOARD FAILURE 75	CONTROL BOARD FAILURE 75, CONTACT FACTORY TECHNICAL SERVICE DEPT.
76	BOARD FAILURE 76	CONTROL BOARD FAILURE 76, CONTACT FACTORY TECHNICAL SERVICE DEPT.
77	BOARD FAILURE 77	CONTROL BOARD FAILURE 77, CONTACT FACTORY TECHNICAL SERVICE DEPT.
<b>80</b>	<b>BOARD FAILURE 80</b>	<b>CONTROL BOARD FAILURE 80, CONTACT FACTORY TECHNICAL SERVICE DEPT.</b>
81	BOARD FAILURE 81	CONTROL BOARD FAILURE 81, CONTACT FACTORY TECHNICAL SERVICE DEPT.
82	BOARD FAILURE 82	CONTROL BOARD FAILURE 82, CONTACT FACTORY TECHNICAL SERVICE DEPT.
83	BOARD FAILURE 83	CONTROL BOARD FAILURE 83, CONTACT FACTORY TECHNICAL SERVICE DEPT.
84	BOARD FAILURE 84	CONTROL BOARD FAILURE 84, CONTACT FACTORY TECHNICAL SERVICE DEPT.
85	EXP PORT PROBLEM	EXPANSION PORT IS SHORT CIRCUITED, TRY DISCONNECTING EXPANSION MODULES OR CONTACT FACTORY TECHNICAL SERVICE DEPT.
86	BOARD FAILURE 86	CONTROL BOARD FAILURE 86, DISCONNECT EXPANSION MODULES. IF NO CHANGE, CONTACT FACTORY TECHNICAL SERVICE DEPT.
87	IEM FAILURE	RESERVED--NOT CURRENTLY USED
88	TCM FAILURE	TIMER CLOSE MODULE (TCM) HAS FAILED
89	FDM FAILURE	FIRE DOOR MODULE (FDM) HAS FAILED
<b>8A</b>	<b>AOM FAILURE</b>	<b>AUXILIARY OUTPUT MODULE (AOM) HAS FAILED</b>
8B	SPARE MOD FAILURE	RESERVED--NOT CURRENTLY USED
8C	LOW SYSTEM VOLTS	POWER SUPPLY LINE VOLTAGE LOW
8D	HI SYSTEM VOLTS	POWER SUPPLY LINE VOLTAGE HIGH
8E	REV INTERRUPTED	GDO LOST POWER OR ENCOUNTERED ANOTHER PROBLEM DURING THE REVERSAL PROCESS, REVERSAL IS COMPLETING NOW
8F	LIMIT MOD. FAIL	GDO WON'T RUN, LIMIT MODULE HAS FAILED
<b>90</b>	<b>DIAGNOSTIC MODE</b>	<b>GDO IS IN DIAGNOSTIC MODE, NORMAL FUNCTIONS ARE NOT ALLOWED</b>
A0	OPEN BTN BAD > PU	OPEN & CLOSE BUTTONS WON'T WORK, THE OPEN BUTTON WAS ACTIVE WHEN THE GDO WAS POWERED-UP
A1	CLOSE BTN BAD > PU	OPEN & CLOSE BUTTONS WON'T WORK, THE CLOSE BUTTON WAS ACTIVE WHEN THE GDO WAS POWERED-UP
A2	ONE BTN BAD > PU	1 BUTTON WON'T WORK, THE 1 BUTTON WAS ACTIVE WHEN THE GDO WAS POWERED-UP
A3	RADIO BAD > PWR UP	RADIO INPUT WON'T WORK, THE RADIO INPUT WAS ACTIVE WHEN THE GDO WAS POWERED-UP
A4	AUX OPEN BAD > PU	AUXILIARY OPEN INPUT WON'T WORK, THE AUXILIARY OPEN INPUT WAS ACTIVE WHEN THE GDO WAS POWERED-UP
A5	OPEN KEY BAD > PU	KEYPAD OPEN & CLOSE KEYS WON'T WORK, THE OPEN KEY WAS ACTIVE WHEN THE GDO WAS POWERED-UP
A6	CLOSE KEY BAD > PU	KEYPAD OPEN & CLOSE KEYS WON'T WORK, THE CLOSE KEY WAS ACTIVE WHEN THE GDO WAS POWERED-UP
A7	MULT KEYS BAD > PU	1 OR MORE KEYPAD CALIBRATION KEYS WON'T WORK, 1 OR MORE WERE ACTIVE WHEN THE GDO WAS POWERED-UP
AA	TCM BAD > POWER UP	RESERVED--NOT CURRENTLY USED
AB	FDM BAD > POWER UP	RESERVED--NOT CURRENTLY USED
<b>B0</b>	<b>OPENING &gt; XMTR #</b>	<b>OPENING FROM TRANSMITTER # ___</b>
B1	CLOSING > XMTR #	CLOSING FROM TRANSMITTER # ___
B2	HALT > XMTR #	HALT FROM TRANSMITTER # ___
B3	NO XMTR > CC	NO CONTROL FROM TRANSMITTER, CONSTANT CONTACT EMPLOYED AT LOCAL CONTROL



# Section 11: Warranty

The Genuine. The Original.



Overhead Door Corporation ("Seller") warrants to the original purchaser of model CDX® commercial operators ("Product"), subject to all of the terms and conditions hereof, that the Product and all components thereof will be free from defects in materials and workmanship under normal use for the following period(s), measured from the date of purchase:

- Two (2) years or 20,000 cycles<sup>1</sup>, whichever occurs first.

Seller's obligation under this warranty is specifically limited to repairing or replacing, at its option, any part which is determined by Seller to be defective during the applicable warranty period. Any labor charges are excluded and will be the responsibility of the purchaser.

This warranty is made to the original purchaser of the Product only, and is not transferable or assignable. This warranty does not apply to any unauthorized alteration or repair of the Product, or to any Product or component which has been damaged or deteriorated due to misuse, neglect, accident, failure to provide necessary maintenance, normal wear and tear, or acts of God or any other cause beyond the reasonable control of Seller.

THIS WARRANTY IS EXCLUSIVE AND IN LIEU OF ANY OTHER WARRANTIES, EITHER EXPRESSED OR IMPLIED, INCLUDING BUT NOT LIMITED TO ANY IMPLIED WARRANTY OF MERCHANTABILITY OR FITNESS FOR A PARTICULAR PURPOSE.

IN NO EVENT SHALL SELLER BE RESPONSIBLE FOR, OR LIABLE TO ANYONE FOR, SPECIAL, INDIRECT, COLLATERAL, PUNITIVE, INCIDENTAL OR CONSEQUENTIAL DAMAGES, even if Seller has been advised of the possibility of such damages. Such excluded damages include, but are not limited to, loss of goodwill, loss of goodwill, loss of profits, loss of use, cost of any substitute product, interruption of business, or other similar indirect financial loss.

Claims under this warranty must be made promptly after discovery, within the applicable warranty period, and in writing to the Seller or to the authorized distributor or installer whose name and address appear below. The purchaser must allow Seller a reasonable opportunity to inspect any Product claimed to be defective prior to removal or any alteration of its condition. Proof of the purchase and/or installation date, and identification as the original purchaser, may be required.

<sup>1</sup> The number of cycles referred to herein shall be measured by an integrated cycle counter contained in or attached to the Product. If the cycle counter is rendered inoperable Seller shall use other reasonable means to determine cycle count.

Model \_\_\_\_\_  
Serial # \_\_\_\_\_  
Manufacturing Date \_\_\_\_\_  
Date of Purchase \_\_\_\_\_  
Original Purchaser \_\_\_\_\_  
Installation Address \_\_\_\_\_  
Name of Distributor/Seller \_\_\_\_\_  
Address of Distributor/Seller \_\_\_\_\_

FOR ASSISTANCE, CALL 800-275-6187

THIS PAGE LEFT BLANK

THIS PAGE LEFT BLANK

**The Genuine. The Original.**



1 DOOR DRIVE  
MT. HOPE, OHIO 44660

CODE 128 BARCODE  
LOCATION

111934.502555

FOR TECHNICAL ASSISTANCE CALL:

1-800-275-6187

[www.overheaddoor.com](http://www.overheaddoor.com)